

# B14

Design Norbert Wangen

Sistema modulare di contenitori base sospesi ad uso intermedio o terminale, senza maniglia, con profilo fascia maniglia sottopiano.

L'impugnatura per l'apertura dell'anta è ottenuta grazie allo smusso superiore dell'anta stessa in combinazione con la fascia maniglia sottopiano e lo smusso perimetrale del piano.

## Piano (1)

Piano caratterizzato da smussi inclinati a vista su uno o più lati, in funzione del progetto.

Testata laterale inclinata a 35°. (Smusso inferiore). (1a)

SPESSORE: 50 mm.

PROFONDITÀ: 505 mm.

LAVABI COMPATIBILI: soprapiano da appoggio, soprapiano da incasso e sottopiano da incasso.

## Contenitore (2)

Realizzato in pannelli di particelle di legno di spessore 19 mm, idrofughi, a basso contenuto di formaldeide (certificato classe E1, CARB P2 / TSCA Title VI) nobilitato con carte ad alta grammatura trattate con resine melamminiche. Bordo anteriore e posteriore in ABS in tinta.

ALTEZZA FIANCO: 300 - 635 mm (entrambe compatibili con lavabi Boffi soprapiano da incasso / sottopiano da incasso / filopiano stampato).

PROFONDITÀ FIANCO: 470 mm.

PROFONDITÀ CON FRONTALE: 495 mm.

LARGHEZZA MODULO: 300 - 450 - 600 - 900 - 1200 mm.

## Ante e frontali (3)

Realizzate in finitura, spessore 23 mm, con smusso superiore (tipo anta BN).

Su frontali di basi ad uso terminale e pannelli terminali smusso aggiuntivo laterale verticale.

## Fascia maniglia sottopiano (4)

Realizzata in alluminio verniciato, è prevista tra piano e anta lungo tutti i lati smussati del piano.

Uso longitudinale. (4a)

Uso laterale. (4b)

FINITURE: bianco - nero.

## Cassetti (5)

Sistema LEGRABOX, con spondine laterali e posteriore in metallo verniciato in colore nero opaco.

Fondo in nobilitato nero.

Frontale cassetti interni in nobilitato finitura contenitore.

## Pannello terminale (6)

Realizzato in finitura, spessore 23 mm.

Smusso su bordo frontale e superiore.

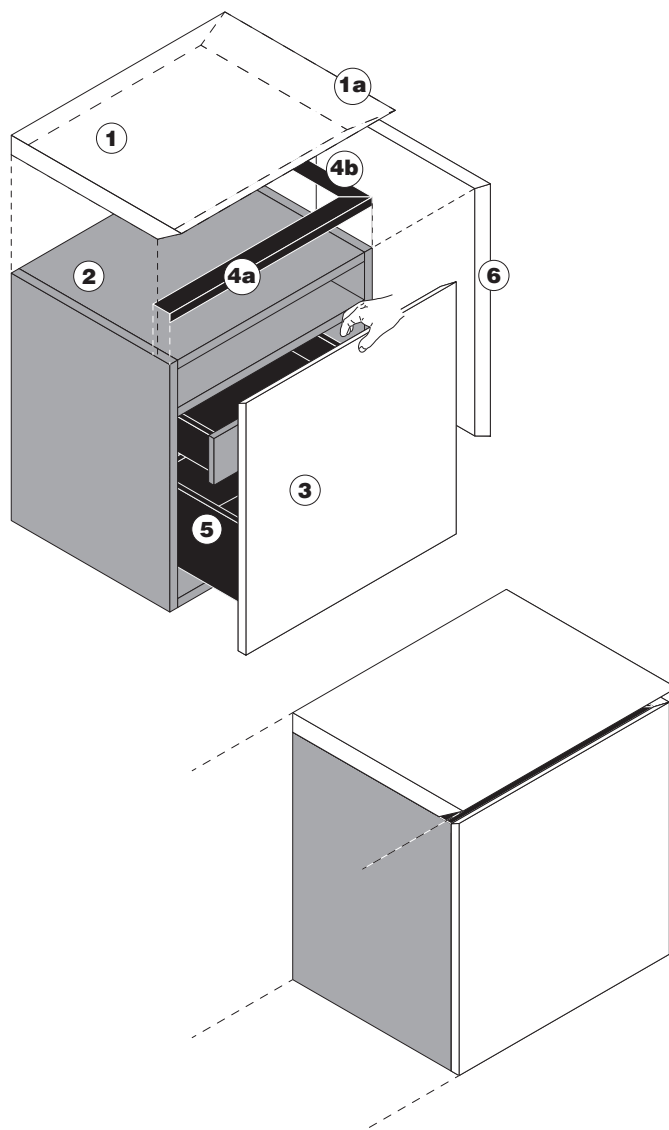



FINITURA FRONTALI COLORI / ESSENZE

EASYLAK+

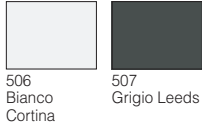
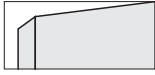

SILCOLAK

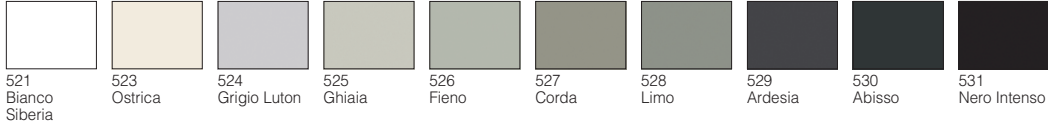
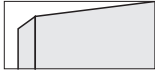

ECOLAK

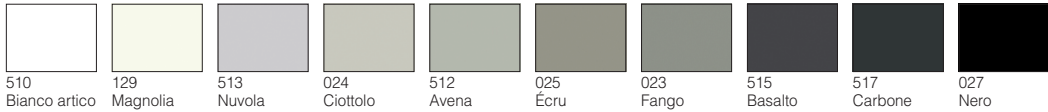
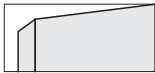

LEGNO

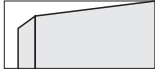

POLIESTERE

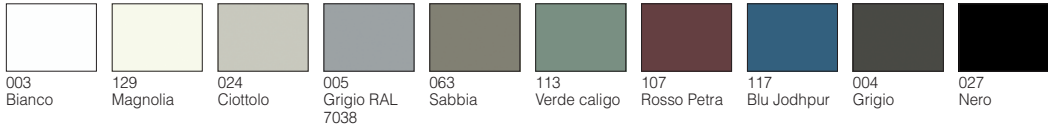

METALS

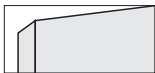

LEGNO SELECTION

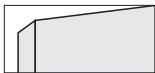

CORIAN®

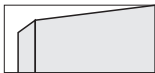

LEGNO MASSELLO

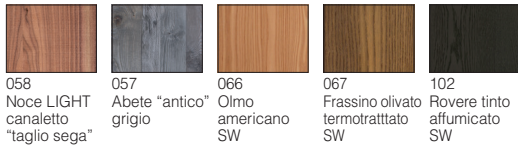

LEGNO EXCLUSIVE





SOPRAPIANO  
da appoggio



SOPRAPIANO  
da incasso



SOTTOPIANO  
da incasso



FILOPIANO  
stampato

FINITURA PIANI      COLORI / ESSENZE

LAVABI

CRISTALPLANT® - H 50 mm

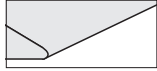

Bianco

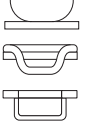

PIETRA - MARMO - GRANITO - H 20 mm



240  
Marmo bianco  
Carrara



250  
Pietra Serena



199  
Granito Nero  
Assoluto  
Zimbabwe



257  
Quartzite  
Silver



261  
Marmo  
Emperador  
Dark



271  
Granito  
Bohemian  
Grey



254  
Granito Black  
Cosmic



259  
Quartzite  
Calacatta



260  
Marmo Grey  
Stone



266  
Marmo bianco  
Carrara  
Lithoverde®



265  
Marmo Gris  
du Marais  
Lithoverde®



267  
Pietra d'Avola  
Lithoverde®

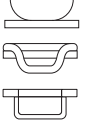

COMPOSITO DEKTON® - H 50 mm

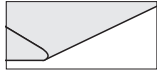

455  
Beige Edora



453  
Nero Sirius



454  
Bianco Zenith



451  
Grigio Strato



457  
Grigio Ventus



458  
Grigio Korus



459  
Marrone  
Galema



461  
Domoos



462  
Keranium



460  
Kelya

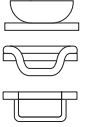

COMPOSITO MDI - H 50 mm

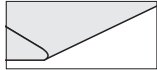

231  
Devon



232  
Surrey

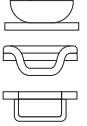

# B14

Design Norbert Wangen

Wall hung, modular base units - middle or end use - without handle, with under-mounted handle-rail.

The door opening is allowed by the upper bevelled-edge door matched with the handle-rail and the bevelled-edge top.

## Top (1)

The tops have visible bevelled edges, on one or more sides, according to the project.

35° slicing. (lower bevelled edge). (1a)

THICKNESS: 50 mm

DEPTH: 505 mm

COMPATIBLE WASHBASINS: top-mounted, built-in and under-mounted.

## Unit (2)

It's made of 19 mm thick wood particle board panels, waterproof, with low formaldehyde emission (class E1, CARB P2 / TSCA Title VI certified), treated with high performance melamine resin. Front and back edges in ABS, same colour

SIDE PANEL HEIGHT: 300 - 635 mm (both compatible with built-in / under-mounted / moulded flush-mounted Boffi washbasins).

SIDE PANEL DEPTH: 470 mm.

DEPTH INCLUDING DOOR: 495 mm.

MODULE WIDTH: 300 - 450 - 600 - 900 - 1200 mm.

## Doors and front panels (3)

Finished, thickness 23 mm, with upper bevelled edge (door type BN).

On end base units and end panels the vertical lateral edges are bevelled too.

## Under top handle-rail (4)

In painted aluminium, placed between top and door, along all bevelled-edge top sides.

Longitudinal use. (4a)

Lateral use. (4b)

FINISHES: white - black.

## Drawers (5)

LEGRABOX series with sides and back in varnished matt black metal.

Black melamine-coated bottom.

Front of internal drawers in melamine, same finish as carcass.

## End panels (6)

In finishing, 23 mm thick.

Frontal and upper bevelled edges.

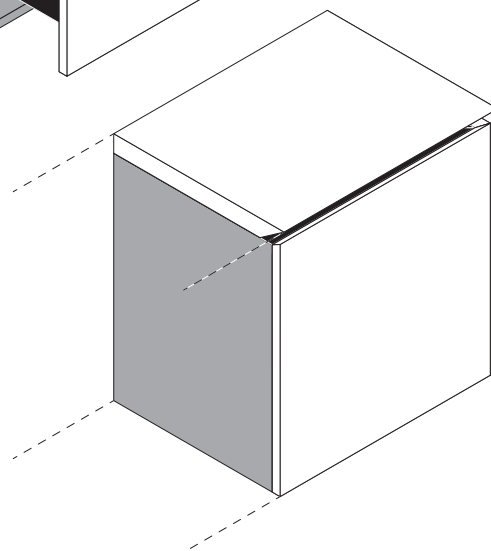
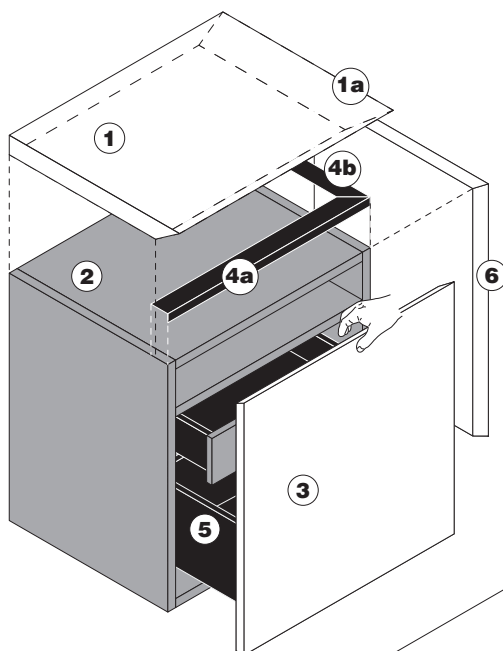

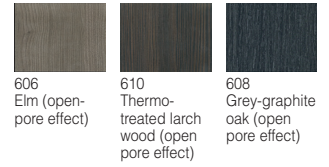

FRONT PANELS FINISH

COLOURS / SPECIES

EASYLAK+

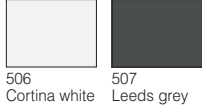

SILCOLAK



ECOLAK

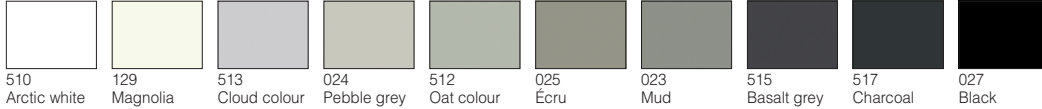

WOOD



POLYESTER

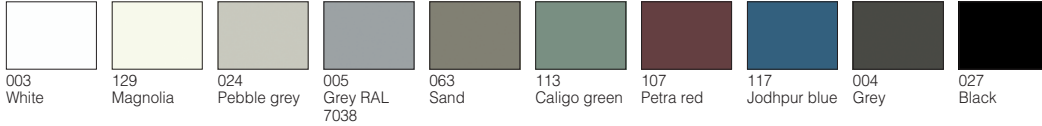
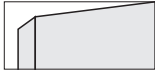

METALS

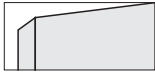

WOOD SELECTION



CORIAN®



SOLID WOOD

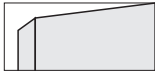

WOOD EXCLUSIVE





TOPS FINISH      COLOURS / SPECIES

WASHBA-  
SINS

CRISTALPLANT® - H 50 mm

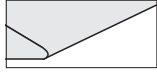

White

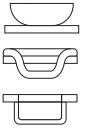

STONE - MARBLE - GRANITE - H 20 mm

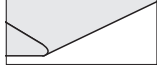

240  
White Carrara  
marble



250  
Serena stone



199  
Absolute black  
Zimbabwe  
granite



257  
Quartzite  
Silver



261  
Emperador  
Dark marble



271  
Bohemian  
Grey granite



254  
Black Cosmic  
granite



259  
Quartzite  
Calacatta



260  
Grey Stone  
marble



266  
White Carrara  
marble  
Lithoverde®



265  
Gris du  
Marais marble  
Lithoverde®



267  
Pietra  
d'Avola stone  
Lithoverde®

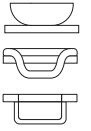

COMPOSITE DEKTON® - H 50 mm



455  
Edora beige



453  
Sirius black



454  
Zenith white



451  
Strato grey



457  
Ventus grey



458  
Korus grey



459  
Galema  
brown



461  
Domoos



462  
Keranium



460  
Kelya

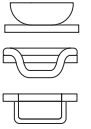

COMPOSITE MDI - H 50 mm

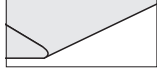

231  
Devon



232  
Surrey

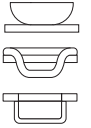

# B14

Design Norbert Wangen

Système modulaire de bases suspendues en utilisation intermédiaire ou d'extrémité, sans poignée, avec profil poignée-bandeau sous plan.

La prise de main pour l'ouverture de la porte est obtenue grâce au chanfrein supérieur de la porte en assortiment avec la poignée-bandeau sous plan et le chanfrein périphérique du plan.

## Plan (1)

Plan caractérisé par chanfreins inclinés apparents sur un ou plus côtés, en fonction du projet.

Tête latérale inclinée à 35°. (Chanfrein inférieure). (1a)

ÉPAISSEUR: 50 mm

PROFONDEUR: 505 mm

LAVABOS COMPATIBLES: sur plan d'appui, sur plan à encastrer et sous plan à encastrer.

## Caisson (2)

Réalisé en panneaux de particules de bois d'épaisseur 19 mm, hydrofuges, à faible teneur en formaldéhyde (certifié classe E1 / CARB P2 / TSCA Title VI) mélaminé avec papiers à haute densité traités avec des résines mélaminiques. Chant avant et arrière en ABS de la même couleur.

HAUTEUR CÔTÉ: 300 - 635 mm (les deux compatibles avec lavabos Boffi sur plan à encastrer / sous plan à encastrer/ affleurants moulés).

PROFONDEUR CÔTÉ: 470 mm.

PROFONDEUR AVEC FAÇADE: 495 mm.

LARGEUR MODULE: 300 - 450 - 600 - 900 - 1200 mm.

## Portes et façades (3)

Réalisées selon les finitions disponibles, épaisseur 23 mm, avec chanfrein supérieur (type porte BN).

Sur façades de bases utilisées en extrémité et panneaux d'extrémité chanfrein supplémentaire latéral vertical.

## Poignée-bandeau sous plan (4)

Réalisée en aluminium peint, elle est prévue entre plan et porte le long de tous les côtés chanfreinés du plan.

Utilisation longitudinale. (4a)

Utilisation latérale. (4b)

FINITIONS: blanc - noir.

## Tiroirs (5)

Système LEGRABOX, avec rebords latéraux et arrière en métal peint en couleur noir mat.

Fond en mélaminé noir.

Façade tiroirs internes en mélaminé finition caisson.

## Panneau d'extrémité (6)

Réalisées selon les finitions disponibles, épaisseur 23 mm.

Chanfrein sur chant avant et supérieur.

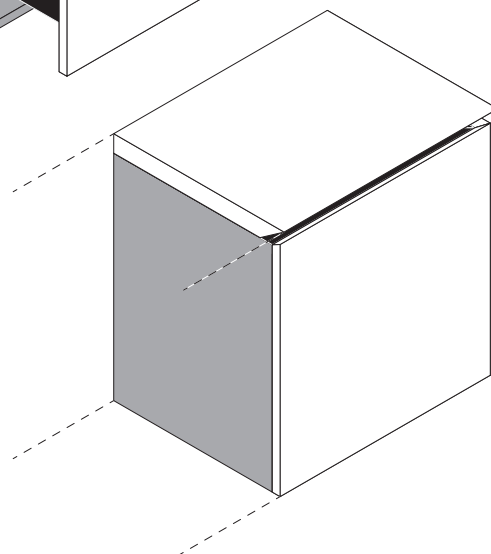
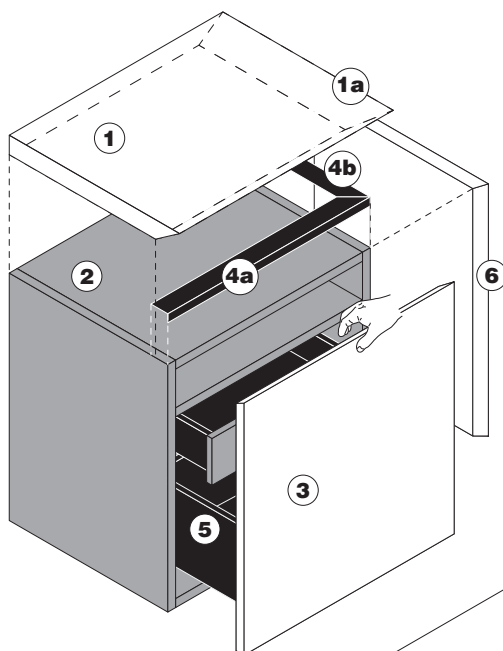

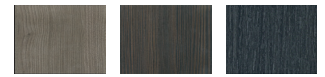

606  
Orme (effet  
pores  
ouverts)

610  
Mélèze  
thermique  
(effet pores  
ouverts)

608  
Chêne  
graphite  
(effet pores  
ouverts)

FINITION FAÇADES COULEURS / ESSENCES

EASYLAK+

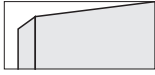

506  
Blanc Cortina

507  
Gris Leeds

SILCOLAK

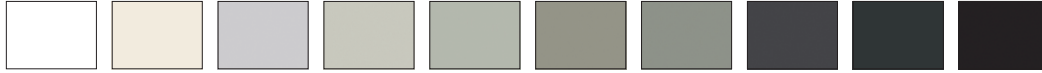
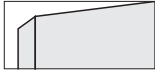

521  
Blanc Sibérie

523  
Huître

524  
Gris Luton

525  
Gravier

526  
Foin

527  
Corde

528  
Limon

529  
Ardoise

530  
Noir abysse

531  
Noir intense

ECOLAK

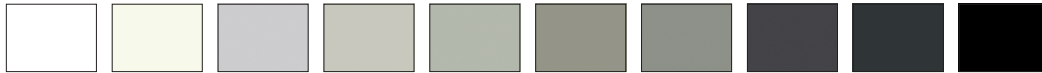
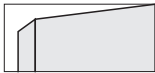

510  
Blanc arctique

129  
Magnolia

513  
Nuage

024  
Galet

512  
Avoine

025  
Ecrû

023  
Boue

515  
Basalte

517  
Charbon

027  
Noir

BOIS

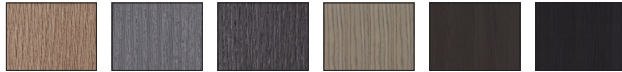
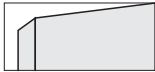

049  
Chêne

033  
Chêne cendré  
gris

076  
Chêne  
graphite

334  
Ecowood Xilo  
2.0 Planked  
Sand (18.22)

335  
Ecowood Xilo  
2.0 Planked  
Grey (18.23)

333  
Ecowood Xilo  
2.0 Striped  
Black (18.04)

POLYESTER

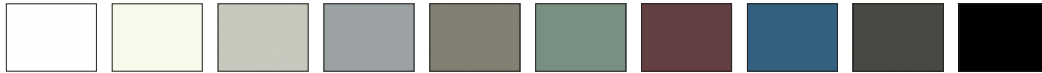

003  
Blanc

129  
Magnolia

024  
Galet

005  
Gris RAL  
7038

063  
Sable

113  
Vert caligo

107  
Rouge Petra

117  
Bleu Jodhpur

004  
Gris

027  
Noir

METALS

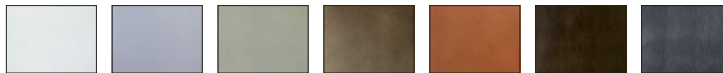
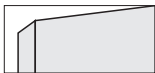

198  
Blanc

934  
Aluminium

197  
Zinc+

195  
Laiton Vintage

196  
Cuivre+

191  
Plomb

192  
Titane

BOIS SELECTION

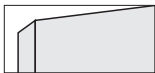

337  
Orme  
Américain

048  
Cœur de  
noyer

093  
Noyer  
"canaletto"  
U.S.

101  
Chêne fumé

CORIAN®

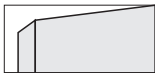

173  
Blanc

BOIS MASSIF



058  
Noyer LIGHT  
canaletto  
"découpe scie"

057  
Sapin  
"antique" gris

066  
Orme  
Américain SW

067  
Frêne olivier  
thermotraité  
SW

102  
Chêne teinté  
fumé SW

BOIS EXCLUSIVE



077  
Abonos fossil  
oak





SUR PLAN  
d'appui



SUR PLAN à  
encastrer



SOUS PLAN  
à encastrer



AFFLEURANT  
moulé

FINITION PLANS

COULEURS / ESSENCES

LAVABOS

CRISTALPLANT® - H 50 mm

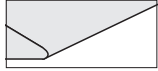

Blanc

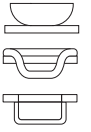

PIERRE - MARBRE - GRANITE - H 20 mm



240  
Marbre blanc  
Carrara



250  
Pierre Serena



199  
Granite  
Noir Absolu  
Zimbabwe



257  
Quartzite  
Silver



261  
Marbre  
Emperador  
Dark



271  
Granite  
Bohemian  
Gris



254  
Granite Black  
Cosmic



259  
Quartzite  
Calacatta



260  
Marbre Grey  
Stone



266  
Marbre blanc  
Carrara  
Lithoverde®



265  
Marbre Gris  
du Marais  
Lithoverde®



267  
Pietra d'Avola  
Lithoverde®

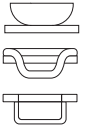

COMPOSITE DEKTON® - H 50 mm

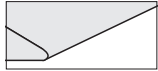

455  
Beige Edora



453  
Noir Sirius



454  
Blanc Zenith



451  
Gris Strato



457  
Gris Ventus



458  
Gris Korus



459  
Marron  
Galema



461  
Domoos



462  
Keranium



460  
Kelya

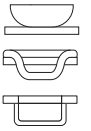

COMPOSITE MDI - H 50 mm

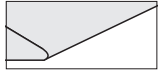

231  
Devon



232  
Surrey

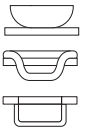

# B14

Design Norbert Wangen

Modulares System aus Hänge-Unterschrank, Zwischen- oder Endunterschrank, ohne Griff, mit Griffleiste unter der Waschtischplatte.  
Die obere abgeschrägte Kante der Tür, die Griffleiste unterhalb der Waschtischplatte und die umlaufende Abwinkelung der Waschtischplatte erleichtern das Öffnen der Tür.

## Waschtischplatte (1)

Waschtischplatte hervorgehoben durch abgewinkelte Kanten an 1 oder mehreren Seiten, je nach Plan.

Seitenbearbeitung 35°. (Unterabschrägung). (1a)

STÄRKE: 50 mm.

TIEFE: 505 mm.

KOMPATIBLE WASHBECKEN: Aufsatz-, Einbau- von oben und Unterbaubecken.

## Schrank (2)

Aus Paneelen aus Spanplatte, Stärke 19 mm, wasserabweisend, mit geringem Formaldehydgehalt (zertifiziert Klasse E1, CARB P2 / TSCA Title VI), mit Melaminharzbeschichtung mit hoher Dichte. Vordere und rückseitige Kante aus ABS in Ausführung.

SEITENTEIL HÖHE: 300 - 635 mm ( beide sind kompatibel mit Einbaubecken von oben / Unterbaubecken / flächenbündigen formgepressten Waschbecken Boffi).

SEITENTEIL TIEFE: 470 mm.

TIEFE MIT FRONTPANEEL: 495 mm.

ELEMENTENBREITE: 300 - 450 - 600 - 900 - 1200 mm.

## Türen und Frontpaneele (3)

In Ausführung, Stärke 23 mm, mit oberer Abschrägung (Tür Typ BN).

An Frontpaneelen von Abschluss-Unterschrank und Abschlusspaneelen zusätzlich vertikale Abschrägung an der Seite.

## Griffleiste unter Waschtischplatte (4)

Aus lackiertem Aluminium, vorgesehen zwischen Waschtischplatte und Tür an allen Seiten der abgewinkelten Waschtischplatte.

Längsseitige Verwendung. (4a)

Seitliche Verwendung. (4b)

AUSFÜHRUNGEN: weiß - schwarz.

## Schubladen (5)

System LEGRABOX, mit rückseitiger Blende und Seitenblenden aus mattschwarz lackiertem Metall.

Boden mit Melaminharzbeschichtung schwarz.

Frontpaneele der Innenschubladen mit Melaminbeschichtung Ausführung Schrankelement.

## Abschlusspaneel (6)

In Ausführung, St. 23 mm.

Abschrägung an Vorder- und Oberkante.

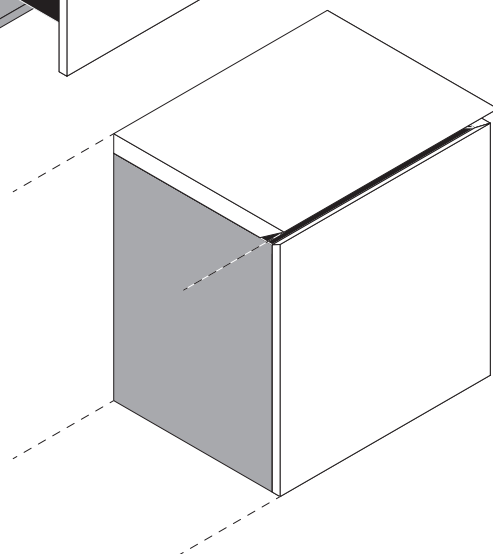
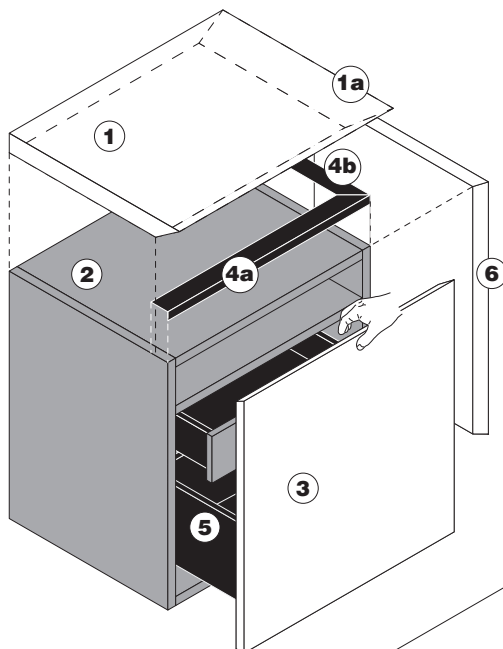

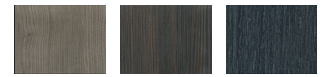

606  
Ulme (Effekt  
offenporig)

610  
Thermoholz  
Lärche (Effekt  
offenporig)

608  
Eiche  
grafitgrau  
(Effekt  
offenporig)

AUSFÜHRUNG  
FRONTEN

FARBEN / HOLZARTEN

EASYLAK+

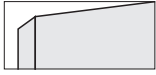

506  
Weiß Cortina



507  
Grau Leeds

SILCOLAK

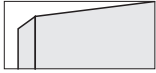

521  
Weiß Sibirien



523  
Perlweiß



524  
Grau Luton



525  
Grau Schotter



526  
Heu



527  
Naturfarben



528  
Schlamm



529  
Ardoise



530  
Völlig schwarz



531  
Tiefschwarz

ECOLAK

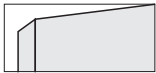

510  
Arktischweiß



129  
Magnolie



513  
Wolkenfarben



024  
Kieselgrau



512  
Haferfarben



025  
Ekrü



023  
Lehm Braun



515  
Basaltgrau



517  
Kohlschwarz



027  
Schwarz

HOLZ

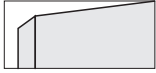

049  
Eiche



033  
Eiche  
Aschgrau



076  
Eiche  
Grafitgrau



334  
Ecowood Xilo  
2.0 Planked  
Sand (18.22)



335  
Ecowood Xilo  
2.0 Planked  
Grey (18.23)



333  
Ecowood Xilo  
2.0 Striped  
Black (18.04)

POLYESTER

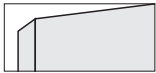

003  
Weiß



129  
Magnolie



024  
Kieselgrau



005  
Grau RAL  
7038



063  
Sandfarben



113  
Grün caligo



107  
Rot Petra



117  
Blue Jodhpur



004  
Grau



027  
Schwarz

METALS

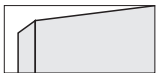

198  
Weiß



934  
Aluminium



197  
Zink+



195  
Messing  
Vintage



196  
Kupfer+



191  
Blei



192  
Titan

HOLZ SELECTION

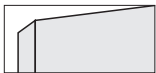

337  
Amerikanische  
Ulme



048  
Kern-  
Nussbaum



093  
Nussbaum  
Canaletto  
U.S.



101  
Räuchereiche

CORIAN®

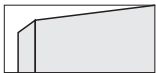

173  
Weiß

MASSIVHOLZ



058  
Nussbaum-LIGHT  
Canaletto  
Sägeschnitt



057  
„Antikes“  
Tannenholz  
grau



066  
Amerikanische  
Ulme SW



067  
Thermo-  
Olivesche SW



102  
Räuchereiche  
gebeizt SW

HOLZ EXCLUSIVE



077  
Abonos fossil  
oak



AUFSATZBECKEN



EINBAUBECKEN  
von oben



UNTERBAUBECKEN



FLÄCHENBÜNDIG  
formgepresst

AUSFÜHRUNG

WASCHTISCHPLATTEN FARBEN / HOLZARTEN

WASCHBECKEN

CRISTALPLANT® - H 50 mm

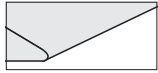

Weiß

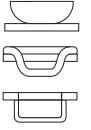

STEIN - MARMOR - GRANIT - H 20 mm

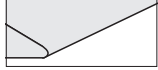

240 Carrara-Marmor weiß



250 Stein Serena



199 Granit Tiefschwarz Zimbabwe



257 Quartzit Silver



261 Marmor Emperador Dark



271 Granit Bohemian Grey



254 Granit Black Cosmic



259 Quartzit Calacatta



260 Marmor Grey Stone



266 Marmor weiß Carrara Lithoverde®



265 Marmor Gris du Marais Lithoverde®



267 Stein Pietra D'Avola Lithoverde®

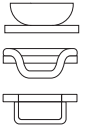

AGGLOMERAT DEKTON® - H 50 mm

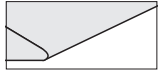

455 Beige Edora



453 Schwarz Sirius



454 Weiß Zenith



451 Grau Strato



457 Grau Ventus



458 Grau Korus



459 Braun Galema



461 Domoos



462 Keranium



460 Kelya

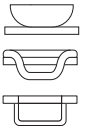

AGGLOMERAT MDI - H 50 mm

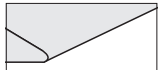

231 Devon



232 Surrey

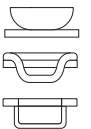

# B14

Design Norbert Wangen

Sistema modular de contenedores bases suspendidos para uso intermedio o terminal, sin tirador, con perfil faja tirador bajotop.  
La empuñadura para abrir la puerta se obtiene gracias al biselo superior de la puerta misma en combinación con el perfil tirador bajo plano y el biselo perimetral del top.

## Top (1)

Encimera caracterizada por chaflanes inclinados a la vista en uno o varios lados, dependiendo del proyecto.

Testata lateral inclinada a 35°. ( Biselo inferior ). (1a)

ESPESOR: 50 mm.

PROFUNDIDAD: 505 mm.

LAVABOS COMPATIBLES: sobre encimera apoyado, sobre encimera empotrado y bajo encimera empotrado.

## Contenedor ( 2 )

Realizados en paneles de partículas de madera grosor 19 mm, hidrofugos, a bajo contenido de formaldeide ( certificado clase E1, CARB P2/ TSCA Title VI) melaminico con papel con alto gramaje tratadas con resnas melaminicas. Borde anterior y posterior en ABS en tinta.

ALTURA COSTADO: 300 - 635 mm (ambas compatibles con lavabos Boffi sobre encimera empotrados / bajo encimera empotrados / enrasados a la encimera moldeados).

PROFUNDIDAD COSTADO: 470 mm.

PROFUNDIDAD CON FRENTE: 495 mm.

ANCHURA MÓDULO: 300 - 450 - 600 - 900 - 1200 mm.

## Puertas y frontales (3)

Realizadas en acabado, grosor 23 mm con biselo superior ( tipo puerta BN).

En fondos de bases a uso terminal y paneles terminal biselo añadido lateral vertical.

## Perfil tirador bajo top ( 4 )

Realizado en aluminio pintado, está prevista entre encimera y puerta a lo largo de todos los lados achaflanados de la encimera.

Uso longitudinal. ( 4a )

Uso lateral. (4b)

ACABADOS: blanco - negro.

## Cajones (5)

Sistema LEGRABOX, con bordes laterales y posteriores en metal lacado en color negro mate.

Fondo de madera ennoblecida negra.

Frontal cajones internos en melaminico acabado contenedor.

## Panel terminal (6)

Realizado en acabado, grosor 23 mm.

Biselo en el borde frontal y superior.

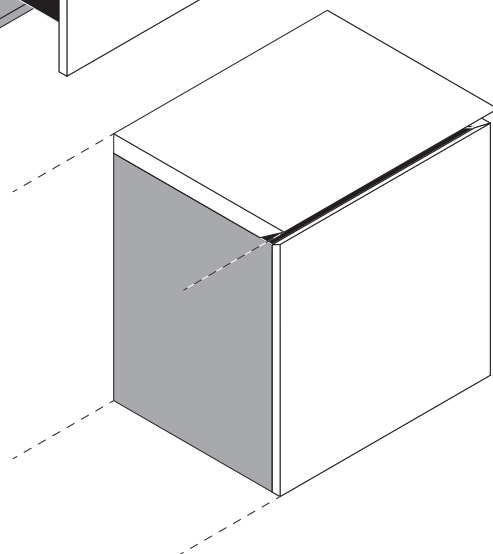
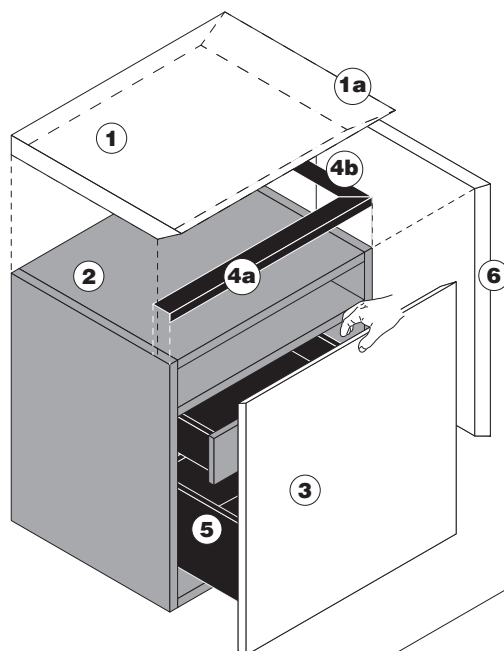



606  
Olmo (efecto  
poro abierto)

610  
Alerce  
termico (efecto  
poro abierto)

608  
Roble grafito  
(efecto poro  
abierto)

ACABADO FRENTES COLORES / MADERAS

EASYLAK+

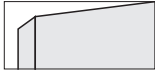

506  
Blanco  
Cortina



507  
Gris Leeds

SILCOLAK

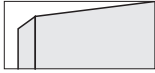

521  
Blanco  
Siberia



523  
Ostra



524  
Gris Luton



525  
Grava



526  
Heno



527  
Cuerda



528  
Limo



529  
Pizarra



530  
Negro Abismo



531  
Negro Intenso

ECOLAK

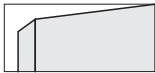

510  
Blanco ártico



129  
Magnolia



513  
Nube



024  
Guijarro



512  
Avena



025  
Crudo



023  
Fango



515  
Basalto



517  
Carbón



027  
Negro

MADERA

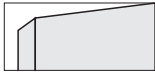

049  
Roble



033  
Roble ceniza



076  
Roble grafito



334  
Ecowood Xilo  
2.0 Planked  
Sand (18.22)



335  
Ecowood Xilo  
2.0 Planked  
Grey (18.23)



333  
Ecowood Xilo  
2.0 Striped  
Black (18.04)

POLIÉSTER



003  
Blanco



129  
Magnolia



024  
Guijarro



005  
Gris RAL  
7038



063  
Arena



113  
Verde caligo



107  
Rojo Petra



117  
Azul Jodhpur



004  
Gris



027  
Negro

METALS

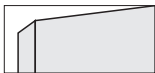

198  
Blanco



934  
Aluminium



197  
Zink+



195  
Laiton Vintage



196  
Cobre+



191  
Plomo



192  
Titanio

MADERA SELECTION

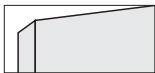

337  
Olmo  
americano



048  
Alma de  
nogal



093  
Nogal canaletto  
(americano)  
U.S.



101  
Roble  
ahumado

CORIAN®

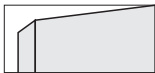

173  
Blanco

MADERA MACIZA



058  
Nogal LIGHT  
canaletto  
"corte sierra"



057  
Abeto  
"antiguo" gris



066  
Olmo  
americano  
SW



067  
Fresno olivado  
termotratado  
SW



102  
Roble teñido  
ahumado SW

MADERA EXCLUSIVE



077  
Abonos fossil  
oak

# B14

ACABADOS REALIZABLES - ENCIMERAS

TIPOS LAVABOS



SOBRE  
ENCIMERA  
apoyado



SOBRE  
ENCIMERA  
empotrado



BAJO  
ENCIMERA  
empotrado



ENRASADO  
A LA  
ENCIMERA  
moldeado

ACABADO ENCIME-  
RAS

COLORES / MADERAS

LAVABOS

CRISTALPLANT® - H 50 mm

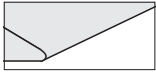

Blanco

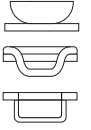

PIEDRA - MÁRMOL - GRANITO - H 20 mm



240  
Mármol  
blanco  
Carrara



250  
Piedra Serena



199  
Granito Negro  
Absoluto  
Zimbabwe



257  
Cuarcita Silver



261  
Mármol  
Emperador  
Dark



271  
Granito  
Bohemina  
Grey



254  
Granito Black  
Cosmic



259  
Cuarcita  
Calacatta



260  
Mármol Grey  
Stone



266  
Mármol blanco  
Carrara  
Lithoverde®



265  
Mármol Gris  
du Marais  
Lithoverde®



267  
Pietra d'Avola  
Lithoverde®



COMPUESTO DEKTON® - H 50 mm

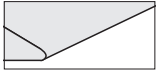

455  
Beige Edora



453  
Negro Sirius



454  
Blanco Zenith



451  
Gris Strato



457  
Gris Ventus



458  
Gris Korus



459  
Marrón  
Galema



461  
Domoos



462  
Keranium



460  
Kelya

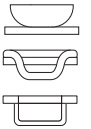

COMPUESTO MDI - H 50 mm

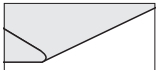

231  
Devon



232  
Surrey

