

KEYPIECE COMMUNICATION DESK. DESKS AND CONFERENCE TABLES

DESIGN: EOOS.

Table top and edge versions

There are two types of edge available.

Advanced:

MDF core with chamfered edge.
Thickness: 28 mm chamfered to 10mm.
Chamfered edge painted.
Finishes: fine-textured paint, .03 paint white, HPL laminate, fenix®, linoleum, linoleum black with silver-coloured edge no. .71 and veneers from price groups IV, V, VI.



Soft:

MDF table top with a gently flowing edge.
Tabletop thickness: 28 mm.
Chamfered edge, painted.

Finishes: available in fine-textured paint (with integrated edge protection) as well as veneers price group IV, V, VI.



Table legs and base

Table base consisting of:

- beam: aluminium profile extrusion
 - joint: die-cast aluminium
 - horizontal cable duct
- Beams, joints, cable ducts and synthetic duct covers are always black-grey.

Legs:

Aluminium leg with integrated cable duct and synthetic cover or solid wood leg. Aluminium legs polished, powder-coated matt bronze or powder-coated matt black. Solid wood legs in oak white pigmented, oiled (.10wo), oak fumed, oiled (.13wo), oak burned, oiled (.14wo) or nutwood with sapwood (.99wo) .

Panel leg:

The extension tables are also available with a panel leg as an option. There is a channel integrated in the panel leg to accommodate cables. The fine-textured paint color must be specified when the order is placed.

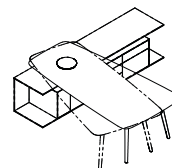

- Function** Extension tables without adjustable height can be swiveled $\pm 30^\circ$ around the attachment point.
- Adjustable height** Desks can be ordered with a height adjustable panel leg, for an additional charge. The height can be adjusted from 75 cm up to 122 cm using the integrated motor.
Cable duct painted in the same color as panel leg.

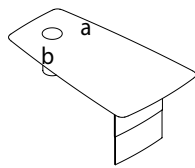

Please specify the position of the manual switch on the order. Please specify the mounting side (a or b), from the viewpoint of the main user.

Notice: Please note that the option of the adjustable height has no PSE certification (Japan).

- Accessories** For versions and accessories see following pages.

KEYPIECE COMMUNICATION DESK

Extension tables

Tables trapezoidal

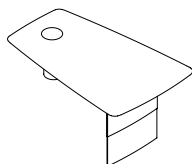
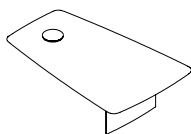
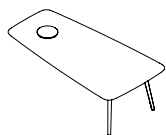

Tables boat-shaped

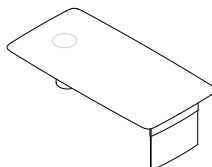
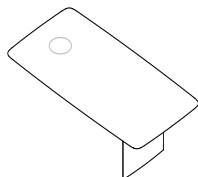
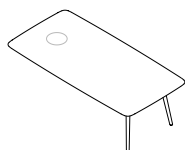

Extension table with two legs or a panel leg
Trapezoidal and boat-shaped extension tables with two legs or a panel leg can be attached to a support pedestal with slide-in or extension pedestals. Optional with Media hub.

All desks with panel leg available as height-adjustable models for an upcharge.

Please see the Keypiece meeting table range for more meeting and conference tables.

Accessoires, cable routing and power supply

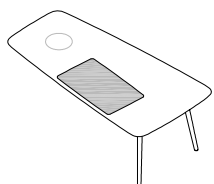

Leather pad

In Congress black leather. Other leathers and leather colors from the collection on request.
W 85 cm, D 55 cm (art.no. 4590)

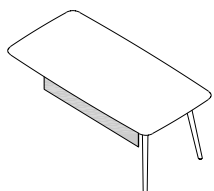

Modesty panel

Black satinised acrylic glass.
(art. no. 4595)

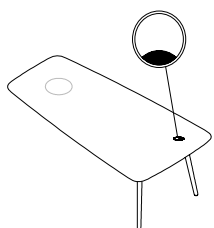

Cable access

For integration to the left or the right of the table top.
Ø 80 mm.
Polished chrome finish or black matt.
Please state which side for installation when ordering. (art. no. 4592 L/R)

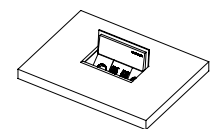

Electrification

Every desk can be equipped with plug-ins for power and different media connectors (This can be found in the back of the price list). Image shows Connector Advanced with soft-close.



Media hub with turntable

(only for trapezoidal extension desks and selected boat-shaped extension desks)

Advanced: in polished chrome.

For the tabel top finish fine-textured paint or paint white .03: The recess on the table top is painted the same colour as the rest of the table top finish. In all the other finish versions, the recess is concealed with a chrome ring.

Soft: For the tabel top finish fine-textured paint or paint white .03: The recess on the table top is painted the same colour - with veneers it is veneered.

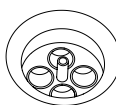

The media hub allows cable routing to the container. 4 cable outlets are integrated. Only 2 cable outlets available for height adjustment.

Connector Netox Point – power supply insert for media hub with turntable

Connector Netbox Point available with different connections. We recommend the allocation of a max. 3 spaces for electrification in a Media Hub to allow one vacant space for cable access.

See chapter Media Conferencing in this Price List.



Sample configuration I

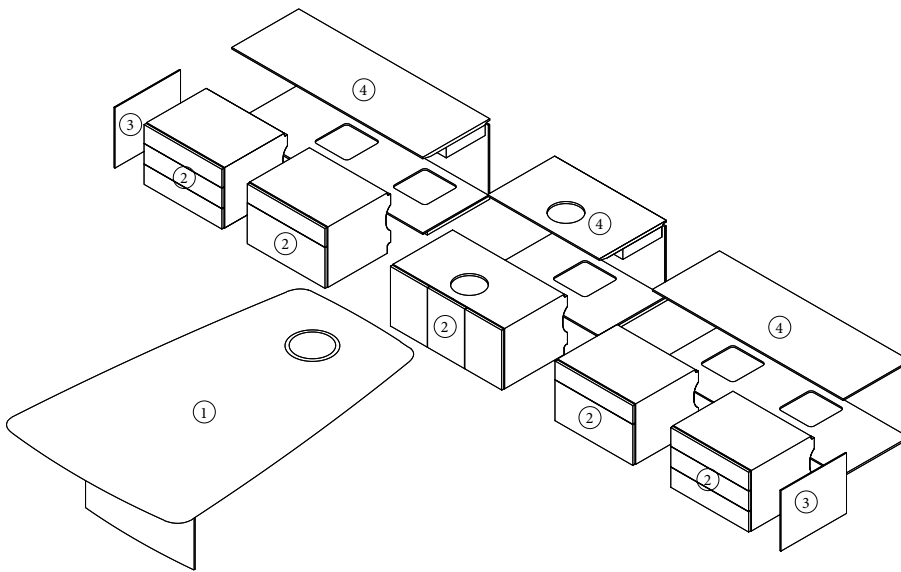

Ordering instructions for extension table with Executive Container

First select the extension table.
 Then select the slide-in container you want or the appropriate supporting container for the extension table moving from left to right.
 Then select the side cover panels model 4554.
 Select the appropriate embraces (453x) for the pull-out pedestal configuration you have chosen.
 Moving from left to right.

Sample configuration II

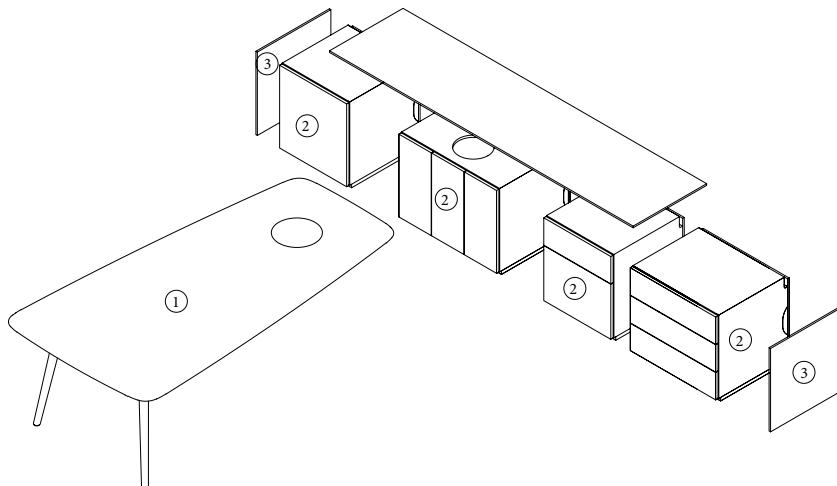

Ordering instructions for extension table with Classic Container

First select the extension table.
 Then select the extension container you want or the appropriate supporting pedestal for the extension table moving from left to right
 Note: the top cover panel is included in the price of the container and need not be ordered separately.
 Lengths of 2.75 m and above is in two parts.
 Then select the side cover panels model 4574.

KEYPIECE COMMUNICATION DESK

extension desk – table top width 210 cm

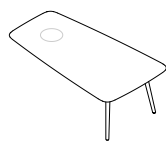

trapezoidal
2 legs

B 210
T 81/117
H 74

W 82¾
D 32/46
H 29¼

4500-A table top Advanced
table top thickness 28 mm
beveled edge

4700-S table top Soft
table top thickness 28 mm
rounded edge

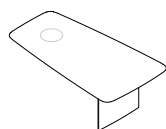

trapezoidal
1 panel leg

B 210
T 81/117
H 74 (75)

W 82¾
D 32/46
H 29¼ (29½)

4501-A table top Advanced
table top thickness 28 mm
beveled edge

4701-S table top Soft
table top thickness 28 mm
rounded edge

extension desk – table top width 230 cm

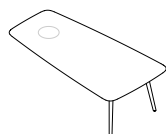

trapezoidal
2 legs

B 230
T 81/119
H 74

W 90½
D 32/46¾
H 29¼

4502-A table top Advanced
table top thickness 28 mm
beveled edge

4702-S table top Soft
table top thickness 28 mm
rounded edge

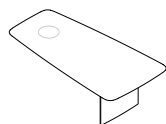

trapezoidal
1 panel leg

B 230
T 81/119
H 74 (75)

W 90½
D 32/46¾
H 29¼ (29½)

4503-A table top Advanced
table top thickness 28 mm
beveled edge

4703-S table top Soft
table top thickness 28 mm
rounded edge

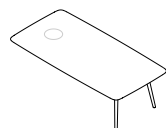

boat-shape
2 legs

B 230
T 113/109
H 74

W 90½
D 44½/43
H 29¼

4555-A table top Advanced
table top thickness 28 mm
beveled edge

4755-S table top Soft
table top thickness 28 mm
rounded edge

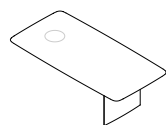

boat-shape
1 panel leg

B 230
T 113/109
H 74 (75)

W 90½
D 44½/43
H 29¼ (29½)

4556-A table top Advanced
table top thickness 28 mm
beveled edge

4756-S table top Soft
table top thickness 28 mm
rounded edge

extension desk – table top width 250 cm

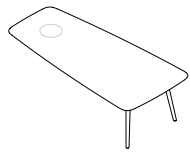

trapezoidal
2 legs

B 250
T 81/120
H 74

W 98½
D 32/47¼
H 29¼

4504-A table top Advanced
table top thickness 28 mm
beveled edge

4704-S table top Soft
table top thickness 28 mm
rounded edge

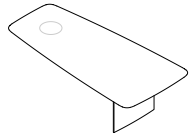

trapezoidal
1 panel leg

B 250
T 81/120
H 74 (75)

W 98½
D 32/47¼
H 29¼ (29½)

4505-A table top Advanced
table top thickness 28 mm
beveled edge

4705-S table top Soft
table top thickness 28 mm
rounded edge

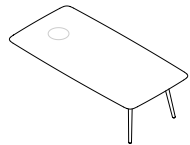

boat-shape
2 legs

B 250
T 113/108
H 74

W 98½
D 44½/42½
H 29¼

4557-A table top Advanced
table top thickness 28 mm
beveled edge

4757-S table top Soft
table top thickness 28 mm
rounded edge

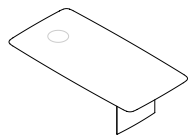

boat-shape
1 panel leg

B 250
T 113/108
H 74 (75)

W 98½
D 44½/42½
H 29¼ (29½)

4558-A table top Advanced
table top thickness 28 mm
beveled edge

4758-S table top Soft
table top thickness 28 mm
rounded edge

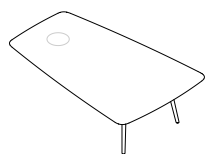

trapezoidal
1 panel leg

B 250
T 106/158
H 74

W 98½
D 41¾/62¼
H 29¼

4506-A table top Advanced
table top thickness 28 mm
beveled edge

4706-S table top Soft
table top thickness 28 mm
rounded edge

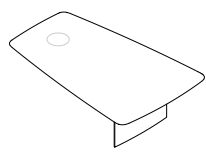

trapezoidal
1 panel leg

B 250
T 106/158
H 74 (75)

W 98½
D 41¾/62¼
H 29¼ (29½)

4507-A table top Advanced
table top thickness 28 mm
beveled edge

4707-S table top Soft
table top thickness 28 mm
rounded edge

KEYPIECE COMMUNICATION DESK

extension desk – table top width 275 cm

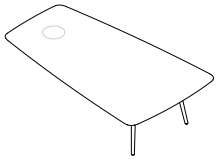

trapezoidal
2 legs

B 275
T 106/158
H 74

W 108¼
D 41¾/62¼
H 29¼

4508-A table top Advanced
table top thickness 28 mm
beveled edge

4708-S table top Soft
table top thickness 28 mm
rounded edge

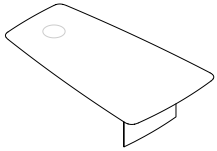

trapezoidal
1 panel leg

B 250
T 106/158
H 74 (75)

W 108¼
D 41¾/62¼
H 29¼ (29½)

4509-A table top Advanced
table top thickness 28 mm
beveled edge

4709-S table top Soft
table top thickness 28 mm
rounded edge

extension desk – table top width 180 cm

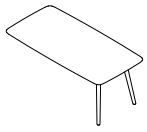

boat-shape
2 legs

B 180
T 86/90
H 74

W 70¾
D 33¾/35½
H 29¼

4510-A table top Advanced
table top thickness 28 mm
beveled edge

4710-S table top Soft
table top thickness 28 mm
rounded edge

extension desk – table top width 200 cm

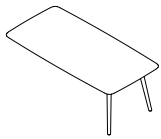

boat-shape
2 legs

B 200
T 96/100
H 74

W 78¾
D 37¾/39¼
H 29¼

4511-A table top Advanced
table top thickness 28 mm
beveled edge

4711-S table top Soft
table top thickness 28 mm
rounded edge

extension desk – table top width 220 cm

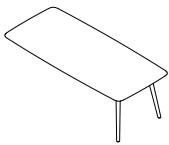

boat-shape
2 legs

B 220
T 95/100
H 74

W 86½
D 37½/39¼
H 29¼

4512-A table top Advanced
table top thickness 28 mm
beveled edge

4712-S table top Soft
table top thickness 28 mm
rounded edge

extension desk – table top width 240 cm

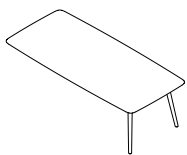

boat-shape
2 legs

B 240
T 104/110
H 74

W 94½
D 41/43¼
H 29¼



4513-A table top Advanced
table top thickness 28 mm
beveled edge

4713-S table top Soft
table top thickness 28 mm
rounded edge

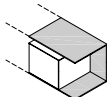

KEYPIECE COMMUNICATION DESK. PEDESTALS

DESIGN: EOOS.

Finishes	Fine-textured paint, .03 paint white or veneers from price groups II, IV, V, VI. Corpus inside: silver grey melamine.	Accessories	For versions, accessories and cable management see the following pages.
Versions	<p>Two different versions of the pedestals are available.</p> <p>Executive Container: An embrace surrounding the slide-in pedestal creates additional finishes.</p>  <p>Classic Container: Traditional pedestal with top and side cover panels.</p>  <p>Please see the overview for more ordering instructions for the pedestals on the following pages.</p>	Doors and drawers	Doors and drawers do not have handles and open with the touch function.
		Plug management	<p>Cable routing: All the pedestals have a hatch approximately 19 cm x 19 cm to allow access to the floor box in the bottom. However cables can also be routed through the lower ventilation slot. There are sections cut out of the sides of every pedestal so that cables can be run through to the adjacent container.</p> <p>Ventilation: All the pedestals have a 25 mm deep opening for ventilation towards the top and towards the bottom between the rear wall and the floor. It extends over the whole width of the pedestal. Manufacturers' instructions regarding the ventilation of any devices must be taken into account.</p>
		Ordering notes	<p><i>If you are ordering more than one desk, please specify clearly which pedestal belongs to which desk.</i></p> <p><i>To ensure that a veneer is consistent over all the pedestals in a row, please supply a drawing with the order.</i></p>

Pedestal „Executive Container“

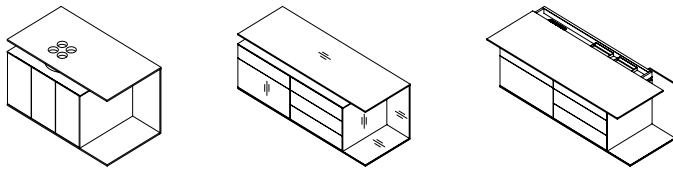

Executive Container

Available as a built-in or support pedestal both with embrace. The embrace can be supplied with a moveable top cover panel as a option (for mod.-no. 4532, 4533, 4534). Once it is removed, the user has access to a utility compartment with a power supply .

Please note the country specific plug equipment (to be found within the notice above the regarding product).

Pedestal „Classic Container“

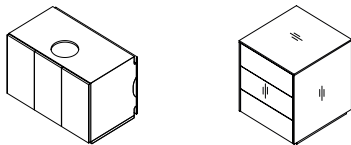

Classic Container

Available as an extension or a support pedestal to be linked to extension tables and with other pedestals.

Accessories and electrification

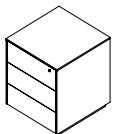

Lock

With integrated drawer interlock. Optional for pedestals. (see art.no. of pedestal)

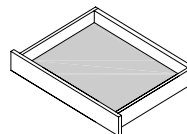

Leather insert for drawers

In Congress leather black. Other leathers from the Walter Knoll Collection on request (for a surcharge). Please state article number of the pedestal when ordering. (art. no. 4582 or 4583)

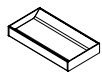

Pencil tray

In Congress black leather. Other leathers from the Walter Knoll Collection on request (for a surcharge). Side cover highly polished chrome plated.

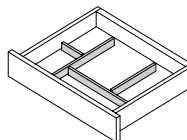

Drawer divider

Position of the drawer divider can be changed with integrated magnets.

In fine-textured paint, black .106.

Note: Only available with the leather insert for drawers.

Please state article number of the pedestal when ordering.

(art. no. 4584, 4585)

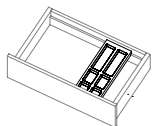

Loose utensil tray

In MDF painted. When ordering, please specify the article number of the pedestal. (Art.-no. 4588 / 4589)

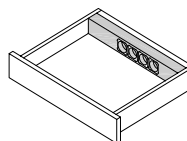

Power supply for top drawer element

Coated matt black.

Please state article number of the pedestal when ordering. (art. no. 4580, 4581)

Please note the country specific plug equipment (to be found within the notice above the regarding product or next to the model number).

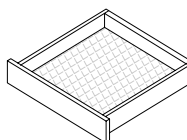

Laptop-compatible construction of top drawer

Perforated insert, painted matt black for ventilation from below.

Please state article number of the pedestal when ordering.

(art. no. 4586, 4587)

KEYPIECE COMMUNICATION DESK

Executive Container

pedestal 55 cm – slide-in pedestal



1 door, 1 shelf

4540

B 55 T 59 H 47

W 21¾ D 23¼ H 18½



2 drawers,
1 with suspension filing frame

4542

B 55 T 59 H 47

W 21¾ D 23¼ H 18½



3 drawers

4544

B 55 T 59 H 47

W 21¾ D 23¼ H 18½



2 drawers, of which
1 is a pull-out printer shelf

4546

B 55 T 59 H 47

Clear dimensions

B 45 T 48 H 21

W 21¾ D 23¼ H 18½

Clear dimensions

W 17¾ D 19 H 13½



1 pull-out
printer shelf

4548

B 55 T 59 H 47

Clear dimensions

B 45 T 48 H 34

W 21¾ D 23¼ H 18½

Clear dimensions

W 17¾ D 19 H 13½

pedestal 70 cm – slide-in pedestal



1 door, 1 shelf

4541

B 70 T 59 H 47

W 27½ D 23¼ H 18½



2 drawers,
1 with suspension filing frame

4543

B 70 T 59 H 47

W 27½ D 23¼ H 18½



3 drawers

4545

B 70 T 59 H 47

W 27½ D 23¼ H 18½



2 drawers, of which
1 is a pull-out printer shelf

4547

B 70 T 59 H 47

Clear dimensions

B 60 T 48 H 21

W 27½ D 23¼ H 18½

Clear dimensions

W 23½ D 19 H 8¾



1 pull-out
printer shelf

4549

B 70 T 59 H 47

Clear dimensions

B 60 T 48 H 34

W 27½ D 23¼ H 18½

Clear dimensions

W 23½ D 19 H 13½

pedestal 80 cm – support pedestal

pedestal 100 cm – support pedestal



3 doors, 1 shelf
Area on the left and right
suitable to accommodate a
PC tower.

4550

B 80 T 59 H 47
Clear dimensions
B 22 T 48 H 43

W 31½ D 23¼ H 18½
Clear dimensions
W 8¾ D 19 H 17



3 doors, 1 shelf
Area on the left and right
suitable to accommodate a
PC tower.

4551

B 100 T 59 H 47
Clear dimensions
B 28 T 48 H 43

W 39¼ D 23¼ H 18½
Clear dimensions
W 11 D 19 H 17

side covers



4554

B 1 T 59 H 47

W ½ D 23¼ H 18½

KEYPIECE COMMUNICATION DESK

embrace

embrace – for slide-in pedestal 55 cm

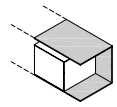

extending either side

4530
B 86 T 60 H 63

W 33¾ D 23½ H 24¾

embrace – for slide-in pedestal 70 cm

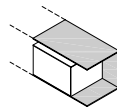

extending either side

4531
B 101 T 60 H 63

W 39¾ D 23½ H 24¾

embrace – for 2 slide-in pedestals 55 cm

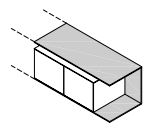

extending either side

4532
B 141 T 60 H 63

W 55½ D 23½ H 24¾

embrace – for slide-in pedestal 55 cm and slide-in pedestal 70 cm

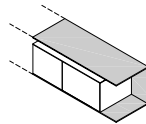

extending either side

4533
B 156 T 60 H 63

W 61½ D 23½ H 24¾

embrace – for 2 slide-in pedestals 70 cm

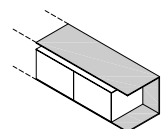

extending either side

4534
B 171 T 60 H 63

W 67¾ D 23½ H 24¾

embrace – for support pedestal 80 cm

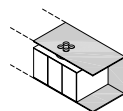

extending either side

4535
B 111 T 60 H 63

W 43¾ D 23½ H 24¾

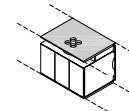

extending either side

4537
B 80 T 60 H 63

W 31½ D 23½ H 24¾

embrace – for support pedestal 100 cm

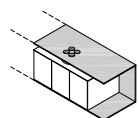

extending either side

4536
B 131 T 60 H 63

W 51½ D 23½ H 24¾

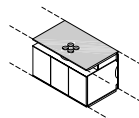

4538
B 100 T 60 H 63

W 39¾ D 23½ H 24¾

pedestal 55 cm – extension pedestal



1 door, 1 shelf

4520

B 55 T 60 H 58,5

W 21¾ D 23½ H 23



2 drawers,
1 with suspension filing frame

4522

B 55 T 60 H 58,5

W 21¾ D 23½ H 23



3 drawers

4524

B 55 T 60 H 58,5

W 21¾ D 23½ H 23



2 drawers, of which
1 is a pull-out printer shelf

4526

B 55 T 60 H 58,5

Clear dimensions

B 45 T 48 H 23

W 21¾ D 23½ H 23

Clear dimensions

W 17¾ D 19 H 9

pedestal 70 cm – extension pedestal



1 door, 1 shelf

4521

B 70 T 60 H 58,5

W 27½ D 23½ H 23



2 drawers,
1 with suspension filing frame

4523

B 70 T 60 H 58,5

W 27½ D 23½ H 23



3 drawers

4525

B 70 T 60 H 58,5

W 27½ D 23½ H 23



2 drawers, of which
1 is a pull-out printer shelf

4527

B 70 T 60 H 58,5

Clear dimensions

B 60 T 48 H 23

W 27½ D 23½ H 23

Clear dimensions

W 23½ D 19 H 9

pedestal 80 cm – support pedestal



3 doors, 1 shelf
Area on the left and right
suitable to accommodate a PC
tower.

4528

B 80 T 60 H 58,5

Clear dimensions

B 22 T 48 H 50

W 31½ D 23½ H 23

Clear dimensions

W 8¾ D 19 H 19¾

pedestal 100 cm – support pedestal



3 doors, 1 shelf
Area on the left and right
suitable to accommodate a PC
tower.

4529

B 100 T 60 H 58,5

Clear dimensions

B 28 T 48 H 50

W 39¼ D 23½ H 23¼

Clear dimensions

W 11 D 19 H 19¾

side panels



4519

B 1 T 60 H 58,5

W ½ D 23½ H 23

KEYPIECE COMMUNICATION DESK

electrical top drawer element/ accessories

electrical top drawer element



Please specify the desired socket face when ordering (not necessary for J/B/L-electrification).

4580

ordering note:
– for pedestal 55 cm wide



Please specify the desired socket face when ordering (not necessary for J/B/L-electrification).

4581

ordering note:
– for pedestal 70 cm wide

leather inlay



4582

ordering note:
– for pedestal 55 cm wide

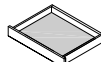

4583

ordering note:
– for pedestal 70 cm wide

drawer dividers



only in combination with leather insert 4582

4584

ordering note:
– for pedestal 55 cm wide



only in combination with leather insert 4583

4585

ordering note:
– for pedestal 70 cm wide

laptop-compatible construction



4586

ordering note:
– for pedestal 55 cm wide

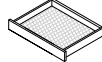

4587

ordering note:
– for pedestal 70 cm wide

leather pad

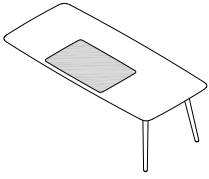

without chamfer

4590

B 85 T 55

W 33½ D 21¾

utensil tray

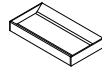

4591

ordering note:

– Suitable for executive pedestal with sliding cover.

cable access



4592

Ø 8

ventilation grill

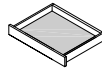

4593

ordering note:

– For all pedestals, where additional ventilation is required.

Recommended when using electrical devices in the pedestal (PC, DVD etc.)

utensil tray for drawers

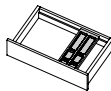
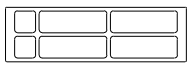

Please give the article number of the pedestal when ordering.

4588

ordering note:

– for pedestal 55 cm wide

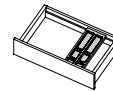

Please give the article number of the pedestal when ordering.

4589

ordering note:

– for pedestal 70 cm wide

KEYPIECE COMMUNICATION DESK

accessories

modesty panel

**4595-1**

B 70 H 34

W 27½ H 13½

ordering note:

- for desks 4501-A, 4701-S, 4510-A, 4710-S

4595-2

B 80 H 34

W 31½ H 13½

ordering note:

- for desks 4500-A, 4700-S

4595-3

B 90 H 34

W 35½ H 13½

ordering note:

- for desks 4503-A, 4703-S, 4511-A, 4711-S,
4556-A, 4756-S**4595-4**

B 100 H 34

W 39¼ H 13½

ordering note:

- for desks 4502-A, 4702-S, 4505-A, 4705-S,
4506-A, 4706-S, 4507-A, 4707-S, 4555-A, 4755-S,
4558-A, 4758-S**4595-5**

B 110 H 34

W 43¼ H 13½

ordering note:

- for desks 4512-A, 4712-S

4595-6

B 120 H 34

W 46½ H 13½

ordering note:

- for desks 4504-A, 4704-S, 4508-A, 4708-S,
4509-A, 4709-S, 4557-A, 4757-S**4595-7**

B 130 H 34

W 52 H 13½

ordering note:

- for desks 4513-A, 4713-S