

# ADD

Francesco Rota | 2014



# ADD

Francesco Rota | 2014

Three letters and creativity takes shape. It arranges, detaches, changes and has fun. It is the ADD seating system, which elegantly meets the needs of contemporary work environments and space sharing. It is also an international award-winning success. Comfortable and versatile, the basic seating represents the first syllable of a language that speaks to different worlds. Two furniture elements can create a sofa. In a line, internal and external backrests join and separate tiny communities, with small tables and accessories for tablets and notebooks included in the composition. Countless combinations, a circle that encompasses the extremities of a meeting.





One seater



Two seater



Three seater



Classic mini



Classic mini — double



Side by side



Vis-à-vis — small

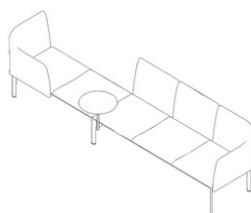

Vis-à-vis — big



Classic



Stool

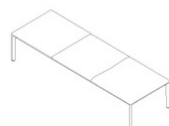

Bench

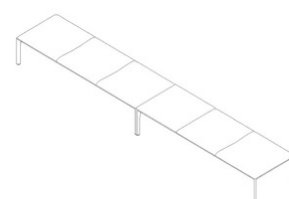

Long bench

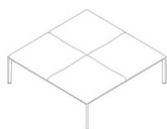

Square bench

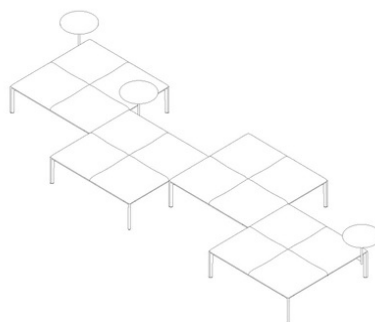

Square bench system



Lounge



Lounge — double

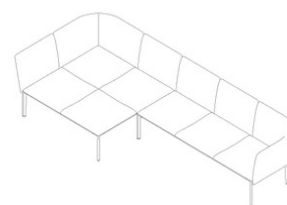

Sofa

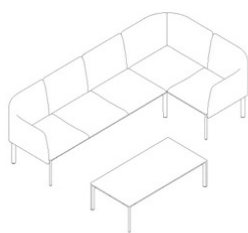

L\_shape

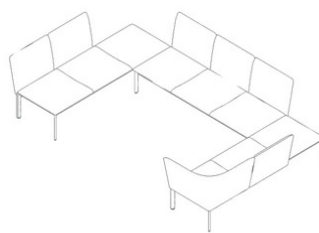

C\_shape

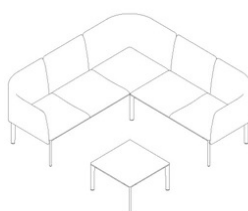

L\_shape — big



L\_shape — open

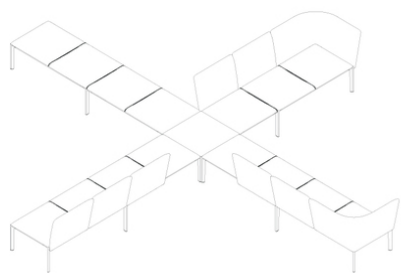

X\_shape

---

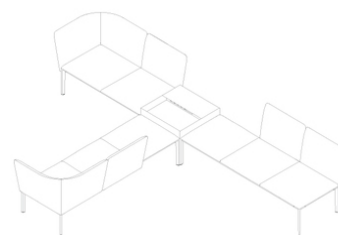

T\_shape

---

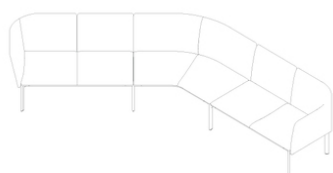

V\_shape in

---



V\_shape out

---

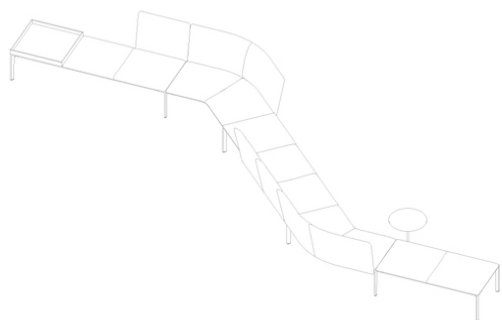

S\_shape

---

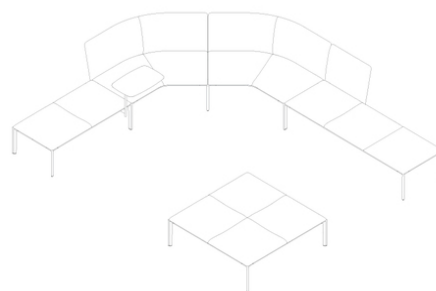

Big lounge

---

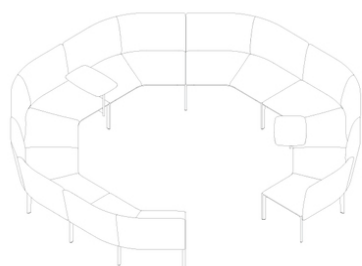

Round in

---

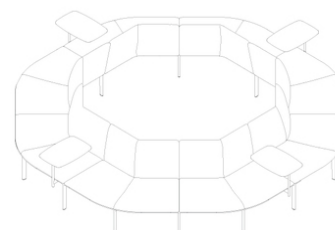

Round out

---

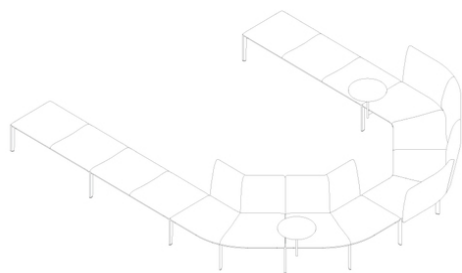

U\_shape

---

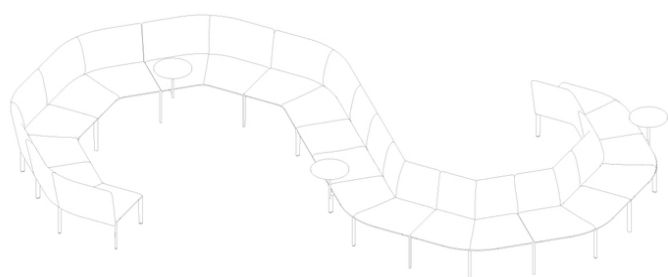

S\_shape — big

---



One

---



Two

---



Four

---

# ADD

Francesco Rota | 2014



Modular seating system with powder coated aluminium frame with webbed elastic support. Two types of recycled die-cast aluminium legs, one for corners and another to connect frames for larger configurations. Each leg type is available in two heights. Backrests and accessories can be fixed to the frame in several positions by using existing holes. Cushions and backrests in moulded polyurethane foam with polyester fiber, all fire-retardant, upholstered with removable fabric, soft leather or eco-leather. ADD is complemented by several accessories in HPL Fenix® 10 mm.: tops, trays, magazine racks, box for sockets. All metal parts are powder coated.

TEST EN 1728:2012 AC:2013 6.17 - EN 16139:2013 - L2 extreme  
TEST 1 IM - Divina, Remix, Steelcut

## legs



## seat frames

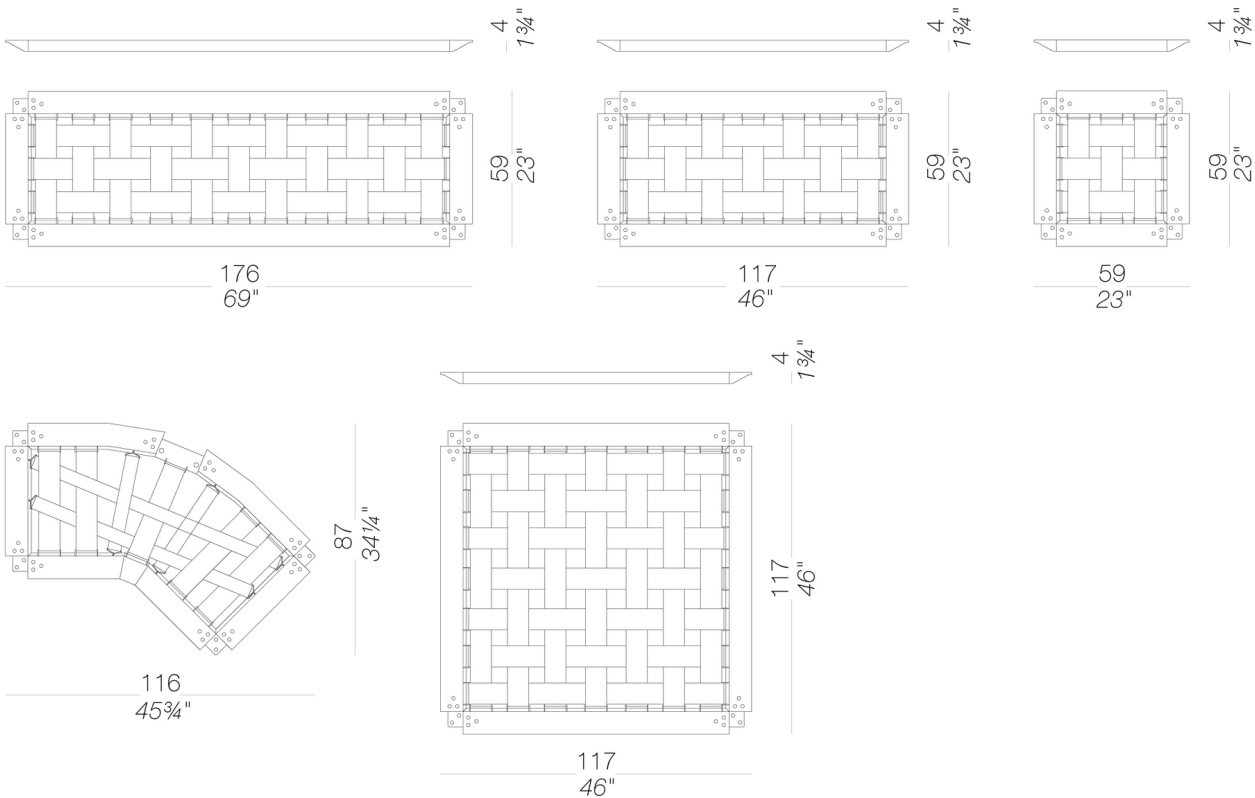

# ADD

Francesco Rota | 2014

## cushions

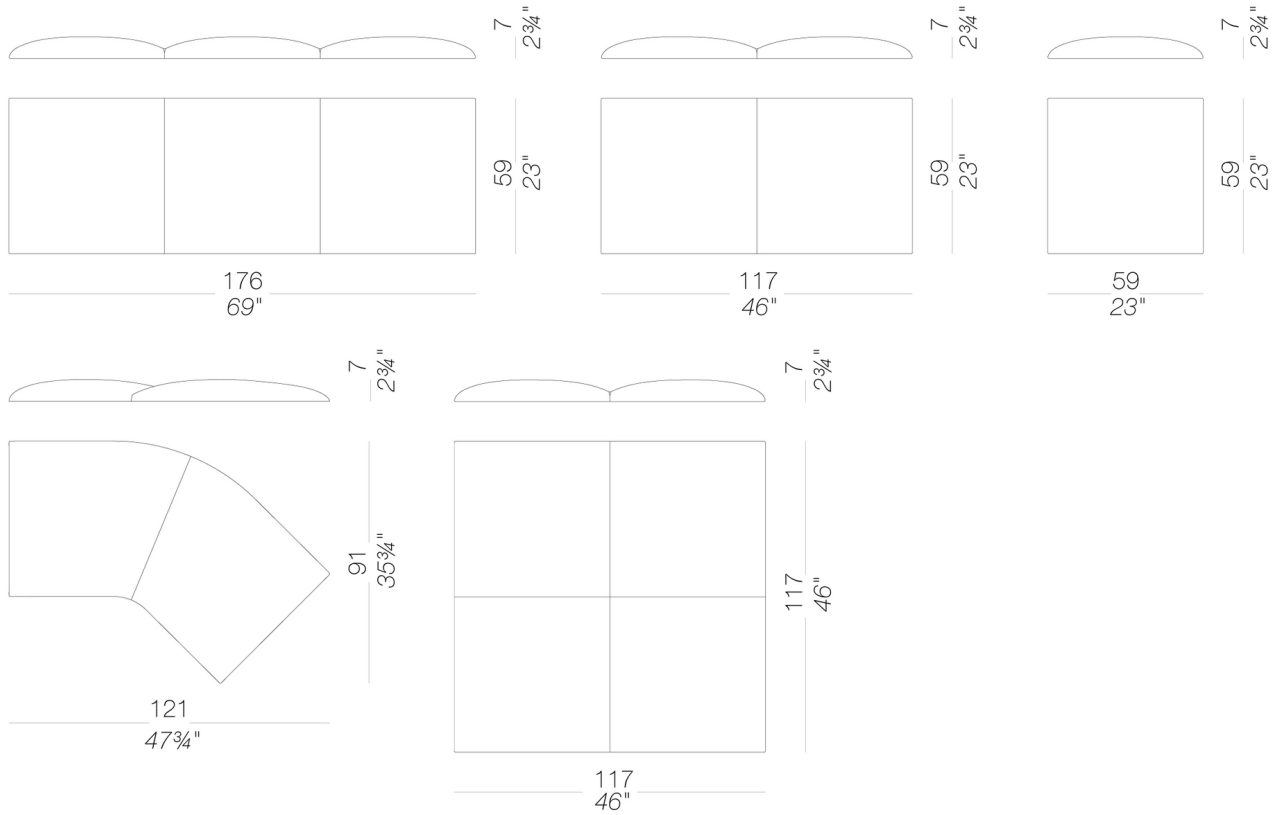

## backs

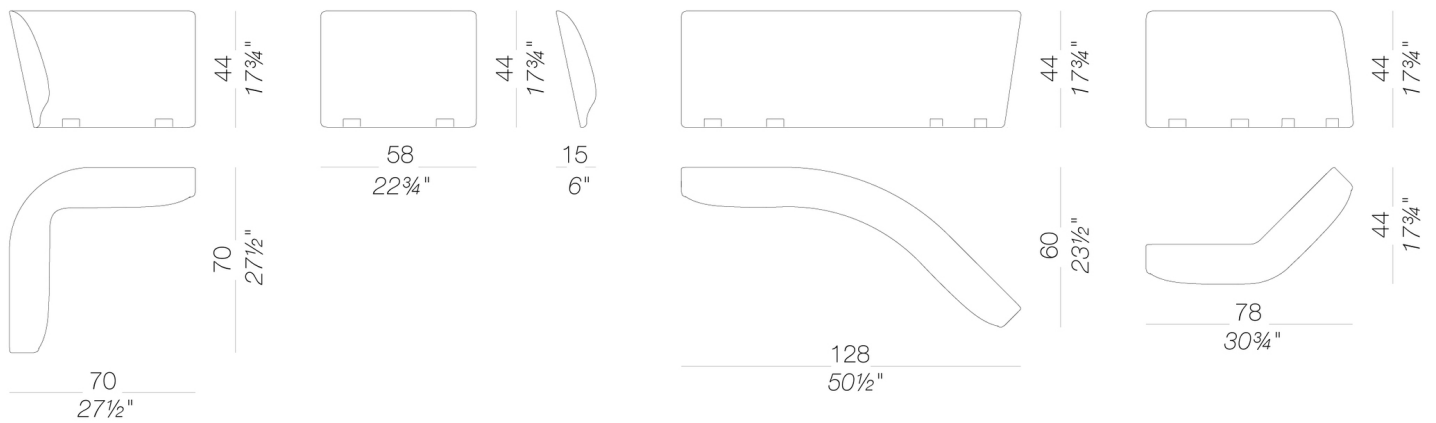

## low table

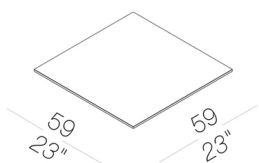



# ADD

Francesco Rota | 2014

## accessories

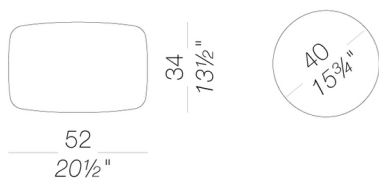
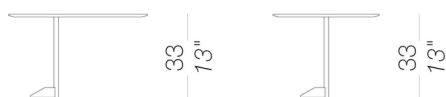
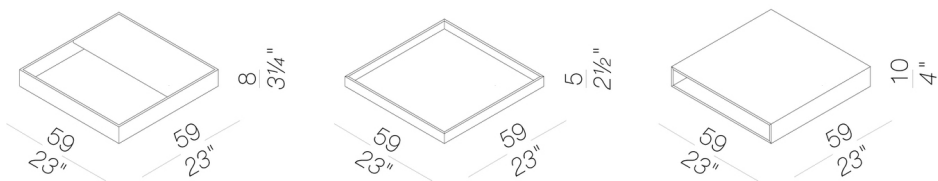

## table frames

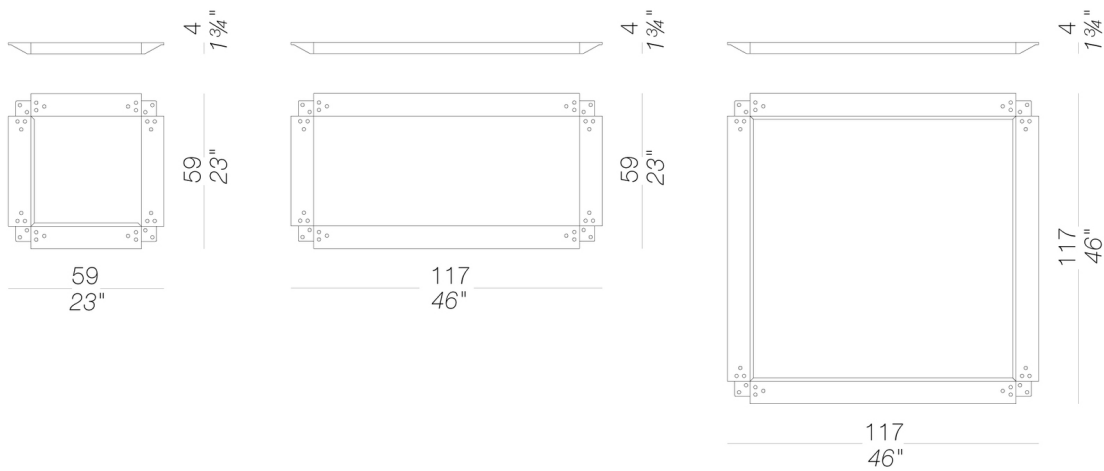

## table tops

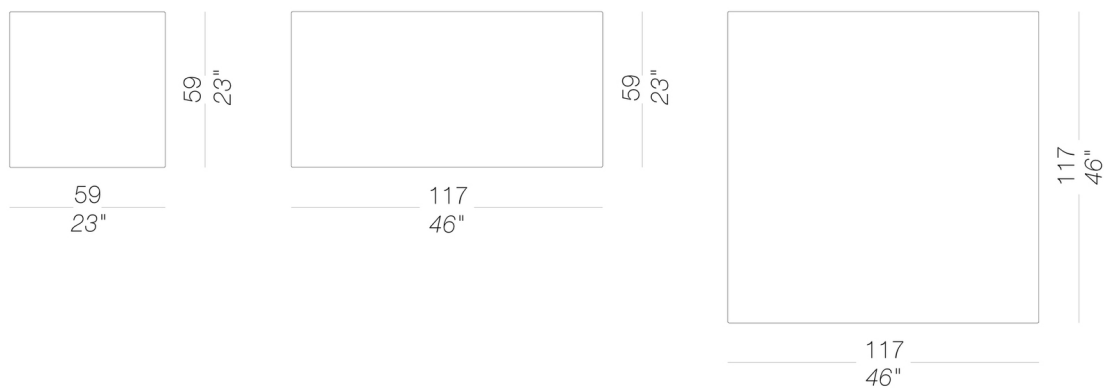

# ADD

Francesco Rota | 2014

## frame



powder coating  
black  
1 Colors

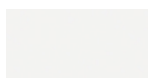

powder coating  
white  
1 Colors

## upholstery



fabric  
Hallingdal 65  
47 Colors



fabric  
Canvas 2  
40 Colors

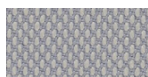

fabric  
Steelcut Trio 3  
48 Colors



fabric  
Remix 3  
24 Colors



fabric  
Clara 2  
24 Colors



fabric  
Divina MD  
24 Colors



fabric  
Divina Melange 3  
24 Colors



fabric  
Medley  
37 Colors

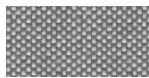

fabric  
Maya  
43 Colors



fabric  
Jet  
44 Colors

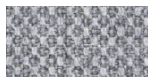

fabric  
Fiord 2  
24 Colors



fabric  
Tonica 2  
39 Colors

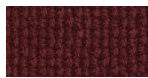

fabric  
Lapalma Smart  
18 Colors

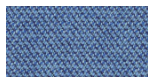

fabric  
Capture  
43 Colors



fabric  
Crisp  
40 Colors



fabric  
Nattè  
23 Colors

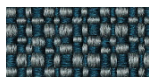

fabric  
Iris  
24 Colors



fabric  
Steelcut 2  
37 Colors

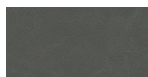

soft-leather  
soft-leather  
7 Colors



ecoleather  
GRIMM FR  
24 Colors



ecoleather  
Valencia c5  
59 Colors

## top



wood  
blanché oak  
1 Colors

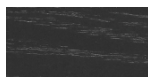

wood  
black open pore  
1 Colors



HPL 10 mm  
HPL fenix  
2 Colors

## accessories

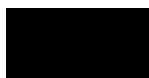

HPL 10 mm  
HPL fenix  
2 Colors

**consult the portfolio for the range of colors, fabrics, eco-leather, soft-leather.**

## use and maintenance instructions

Clean all parts in wood, leather, fabric and metal with a damp cloth or a diluted neutral cleaner. Do not use cleaners with alcohol, bleach, solvent or abrasive products. Any liquid spilt on the product must be wiped up immediately. When lifting or moving the product, hold it on the structure and not under the seat. The product should not be subjected to unbalanced weights, as it is designed for a proper rest on the foothold (on four legs or on the base). Our company relieves from any responsibility in case of damage caused to fragile floors. Avoid any improper use of the product: do not step on the product, on the footrest or on the armrests. Avoid any movements that could compromise the proper functionality of the product or the safety of the users. Wood and leather, being natural materials, could be easily damaged. Small impurities or imperfections are within quality standard range. Do not expose the product to weather conditions or atmospheric agents, nor to heat sources over 40°C. Also products for outdoor use could be afflicted by atmospheric agents. The product could undergo possible exterior changes due to particular exposure to heat, humidity and saltiness. An appropriate and frequent maintenance and cleaning of the product enhances its durability. The product could change colour and shade, if exposed to direct sunlight. Maintenance has to be carried out by experienced staff. Dispose of the package only after assembling the product, in order to avoid the loss of ironmongery and components. Once the product has been dismantled, the product itself or its components must be given to the public garbage disposal system, according to the legislation in force.