

**YUUTO.** Design: EOOS.

---



Good design always starts off as a good idea. And that was the case with Yuuto. An upholstered bed. Spaciously designed with fine materials. But this bed is more: Yuuto shapes the room. The upholstered bench naturally takes up residence beside the bed. An attractive addition – the escritoire with its surface made of premium saddle leather. Complementing this arrangement, the side table – the perfect spot for your book and jewellery during the night. Inspirations en détail for wide sleeping landscapes. Relaxed elegance – as serene as it is stylish. With the culture of the natural.

## Product description

---

**Modell no.** 810

---

**Bed frame**  
**Frame:** wooden construction.  
**Base:** lacquered in black.  
**Upholstery:** cold cure foam with textile covering.

---

**Versions**  
**Bed frame versions for sleeping system/mattress dimensions:**  
- 140 x 200 (210/220) cm  
- 160 x 200 (210/220) cm  
- 180 x 200 (210/220) cm  
- 200 x 200 (210/220) cm  
- Queensize 152 x 203 cm  
- Kingsize 193 x 203 cm  
- California Kingsize 183 x 213 cm

**Special length:**

The bed frame for sleeping systems 140, 160, 180 and 200 cm wide, is also available in a special length of 210 or 220 cm (for surcharge).

---

**Headboard**  
**Frame:** wooden construction.  
**Upholstery:** cold cure foam with an outer layer of wadding.

**Versions:**  
- headboard flush with bed frame  
- headboard protruding either side (for surcharge).

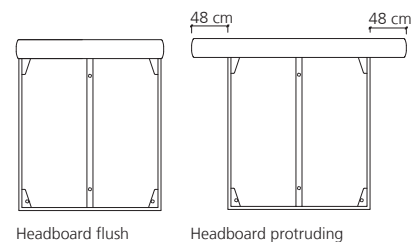

**Glides**  
**Base:** fitted with synthetic glides.  
**Adjustable feet:** fitted with stoppers, adjustable feet to compensate for uneven floors.

---

## YUUTO.

### Sidetable, escritoire and upholstered seats

#### Sidetable:

- in leather Saddle
- optionally with plastic swivel-out-drawer laquered in bronze, inlay in leather saddle with the same colour as the sidetable.
- Glides: teflon or felt glides.

#### Escritoire:

- Top: leather Saddle
- Frame: steel, powder-coated bronze matt
- Glides: synthetic glides.

#### Upholstered seats:

- Customers can choose from four upholstered seats to place behind the headboard or at the foot of the bed.
- Frame: wooden construction.
- Upholstery: cold cure foam with an outer layer of wadding.
- base: lacquered in black.
- Glides: fitted with teflon or felt glides.

### Sleeping system and fitted depth

The **fitted depth** is the depth to which the sprung section and the mattress sink into the bed frame.

It can be adjusted to **3 positions** (varying the clearance from the floor to the underside of the sleeping system):

- 18 cm (14 cm)
- 16 cm (16 cm)
- 14 cm (18 cm)

The bed frame is therefore suitable for most of the commonly available sleeping systems.

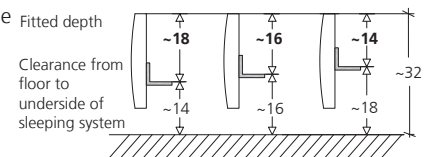

#### For example:

The Walter Knoll Sleeping System (base mattress and top mattress) is ~33 cm deep. With a fitted depth of ~16 cm (see drawing fitted depth 16 cm), the sleeping system sinks ~16 cm into the bed frame and protrudes ~17 cm above it. The mattress sinks 6 cm into the bed frame. This means that this sleeping system is held securely in the bed frame.

For a **firm hold** of the mattress in the bed frame we recommend to use sleeping systems which sink a **minimum of 6 cm** into the bed frame.

In case of a sprung section with an **electric motor**, a clearance from floor to underside of the sleeping system of at least 16 cm is required.

For prices and more information about the mattresses recommended by Walter Knoll, see *Walter Knoll Sleeping Systems*.

Fitted depth 18 cm

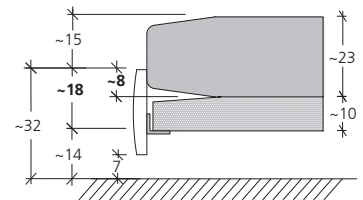

Fitted depth 16 cm

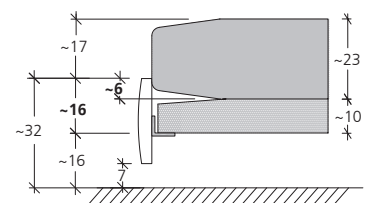

Fitted depth 14 cm

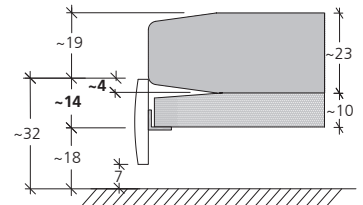

Notice: all dimensions in cm.  
Please note, that the drawings are only schematic diagrams..

# WALTER KNOLL

## YUUTO.

---

### Ordering notes

1. First choose the size of the mattress/base mattress and select the appropriate bed frame.
2. Then choose the cover of the bed frame and the headboard.
3. Specify the version of the headboard: flush or with protruding ends.
4. Choose optionally:
  - sidetables
  - escritoire
  - upholstered seats
5. Finally choose the preferred sleeping system. We recommend the sleeping system of Walter Knoll - see sleeping systems.

**Please note:** the Walter Knoll Sleeping System is not available for deliveries to the United Kingdom.

---

### Notice

The cover of both the bed framework and headboard can be removed.

The framework is not assembled on delivery. The framework cover is attached on site.

The headboard comes upholstered. With models 810-160, 810-180, 810-200, 810-152, 810-193 and 810-183 with protruding, the headboard consists of two parts which are screwed to a solid base during assembly. The headboard covers are fastened together with zips. This ensures the headboard looks as if it is all one piece.

The length of the individual elements on delivery is max. 290 cm depending on the model.

---

### Bed Frame - basic dimensions

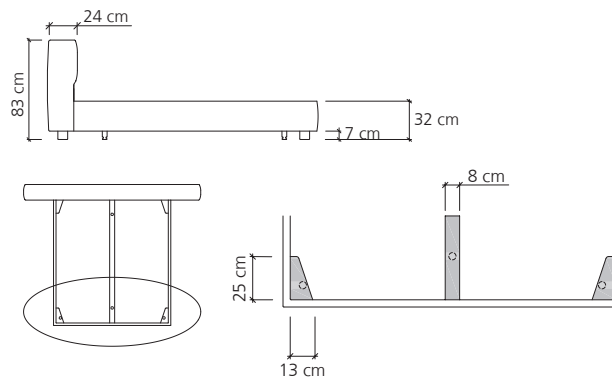

## YUUTO.

### Technical drawings and dimensions

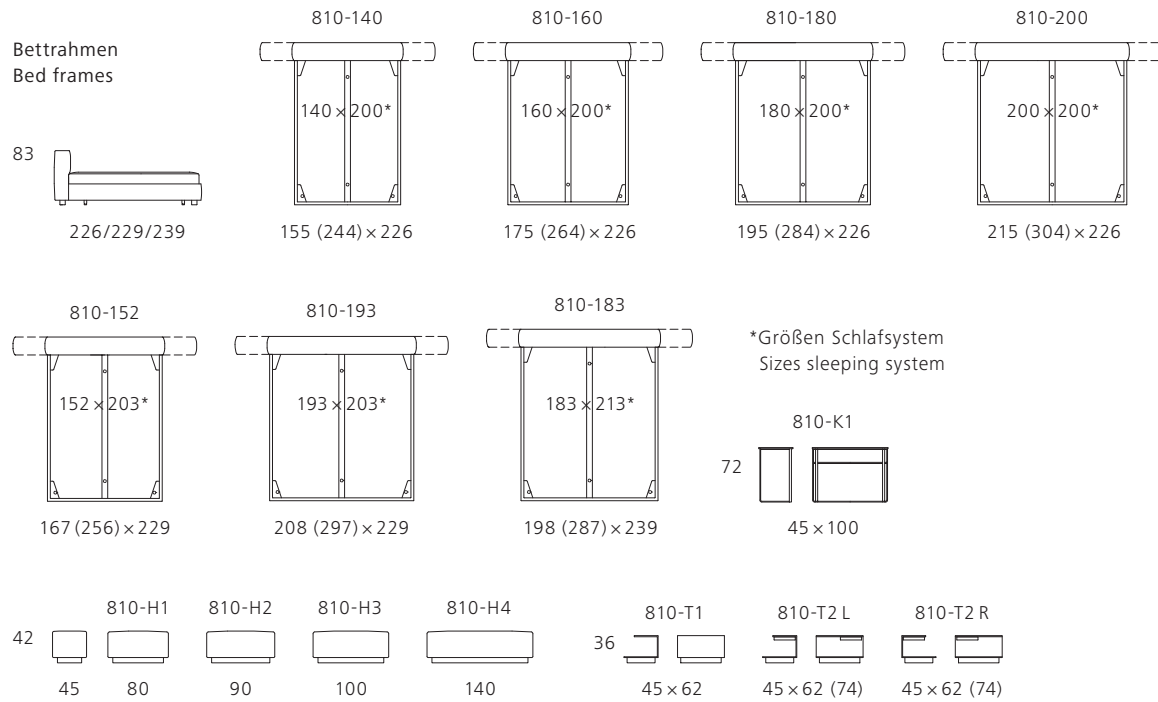

Alle Maßangaben in cm. *All dimensions in cm.*

All dimensions in cm.