Michel

SOFAS

Antonio Citterio



Description

Designed for those who love comfort and modernity, intended to be an evergreen, the Michel seating system mirrors the design philosophy of its author who shows a preference for simple shapes - pure and elegant in their linear form without any additional decoration to underscore the concept of function. The many elements can create both formal and social configurations in an extensive range of sizes. Distinctive features include the aluminium frame and the seat cushion.

Technical information

Back and armrest internal frame:
tubular steel and steel profiles

Back and armrest internal frame upholstery:
Bayfit® (Bayer®) flexible cold shaped polyurethane foam, polyester fibre, polyester fibre cover

Seat internal frame:
painted tubular steel and steel profiles, multilayered wood panel, shaped polyurethane

Seat cushion upholstery:
shaped polyurethane of different density, sterilized down, polyester fibre cover

Back cushion (M60C-M50):
upholstery : down feather + polyurethane section, typology : box style

Back cushion with roller (M60CP-M50P):
upholstery : down feather + polyurethane section + polyester fibre, typology : box style + roller

Support frame:
painted black chrome, pewter painted, bronzed nickel painted or bright brushed die-cast aluminium and extrusions

Ferrules:
thermoplastic material

Cover:
fabric or leather

Technical drawings

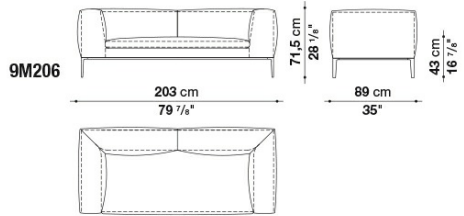

9M206

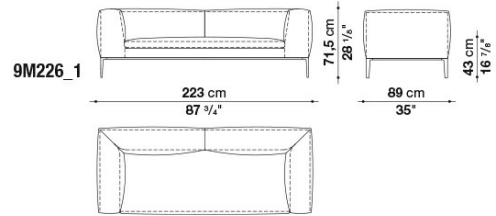

9M226_1

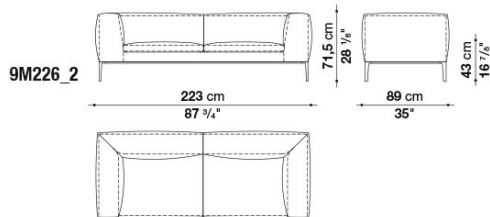

9M226_2

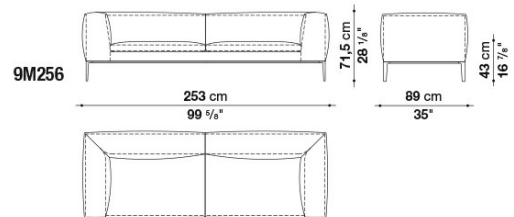

9M256

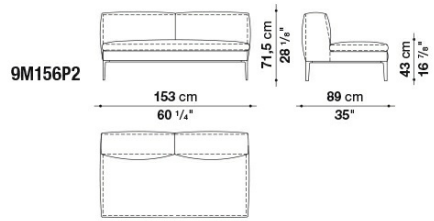

9M156P2

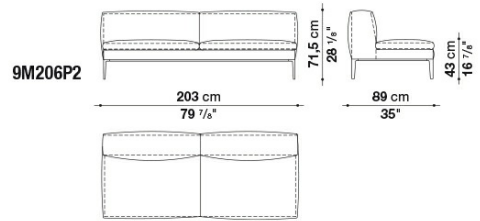

9M206P2

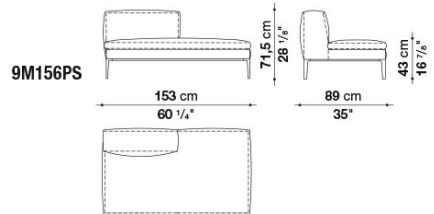

9M156PS

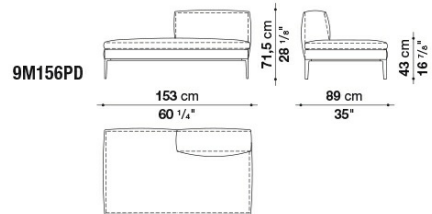

9M156PD

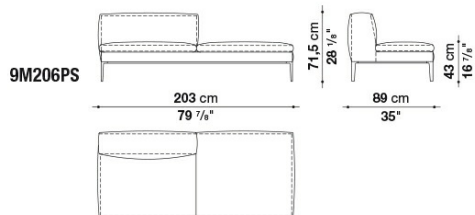

9M206PS

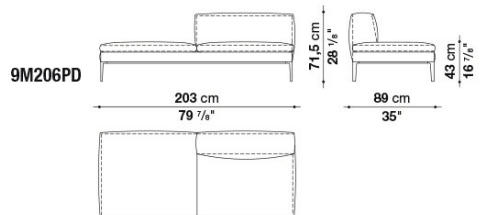

9M206PD

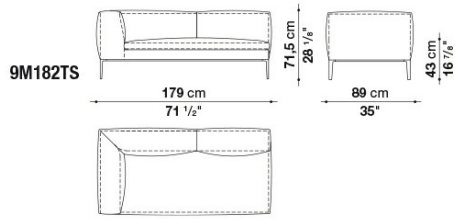

9M182TS

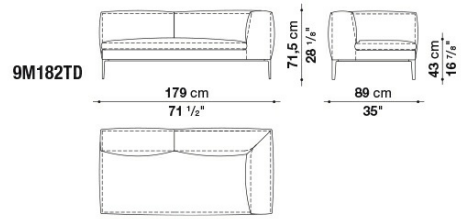

9M182TD

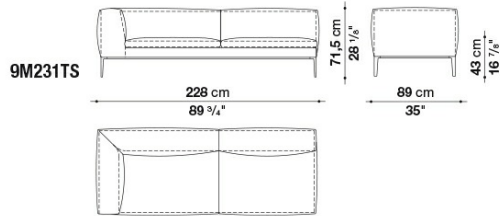

9M231TS

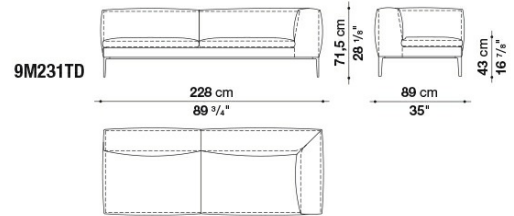

9M231TD

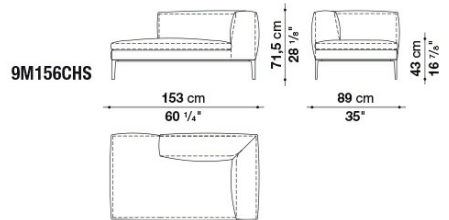

9M156CHS

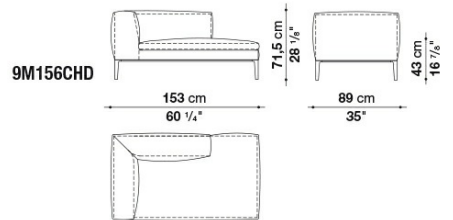

9M156CHD

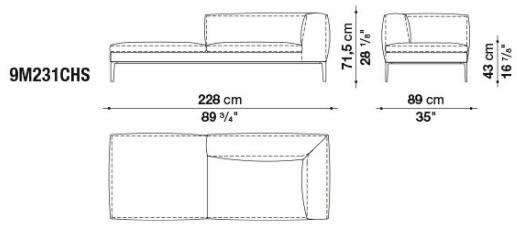

9M231CHS

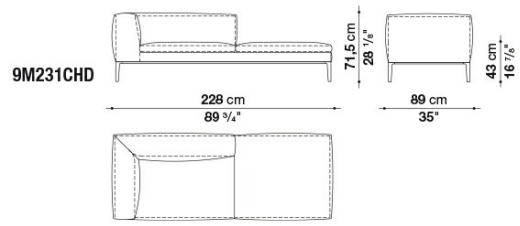

9M231CHD

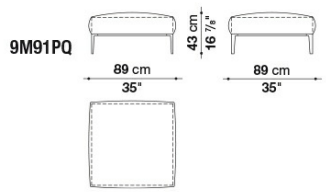

9M91PQ

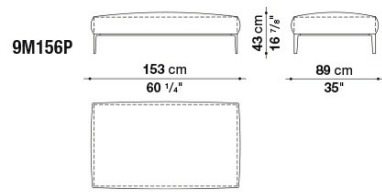

9M156P

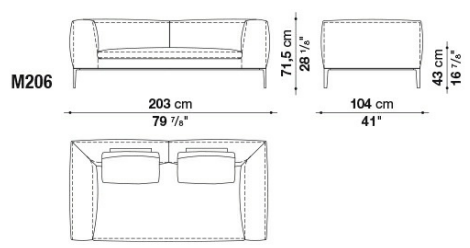

M206

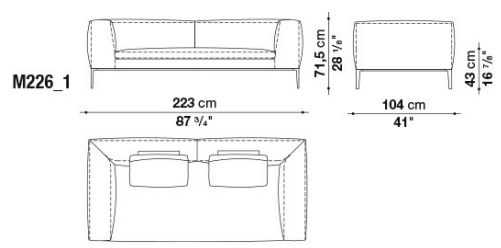

M226_1

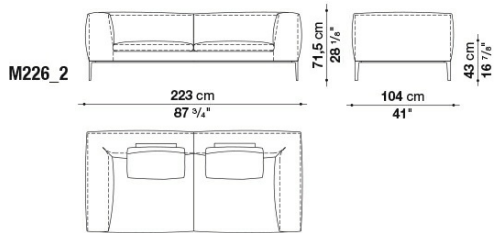

M226_2

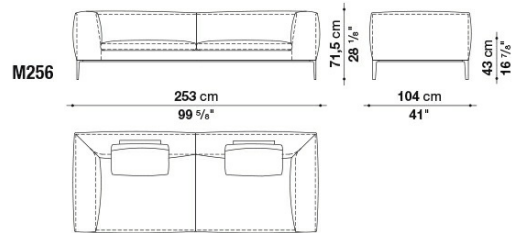

M256

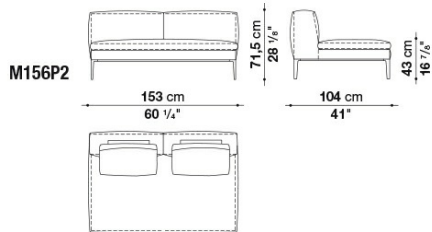

M156P2

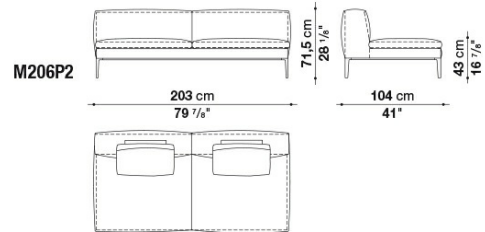

M206P2

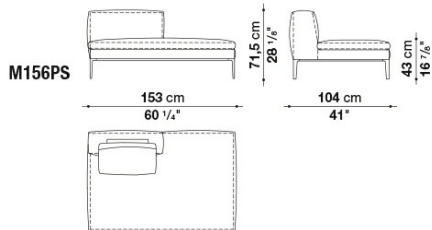

M156PS

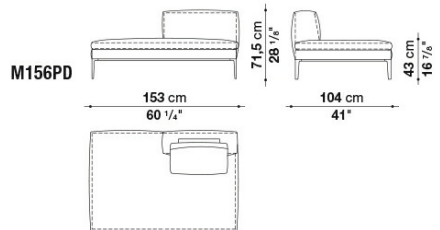

M156PD

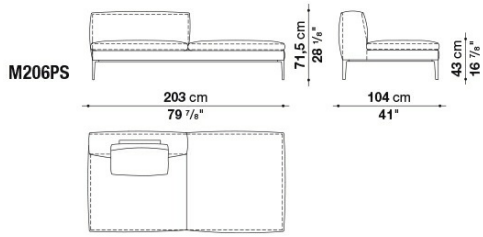

M206PS

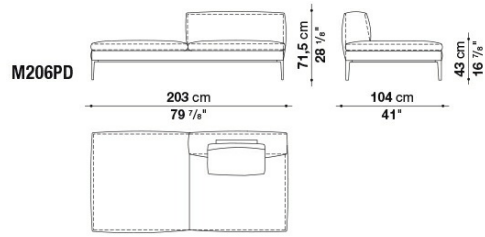

M206PD

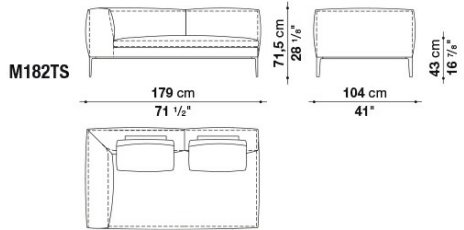

M182TS

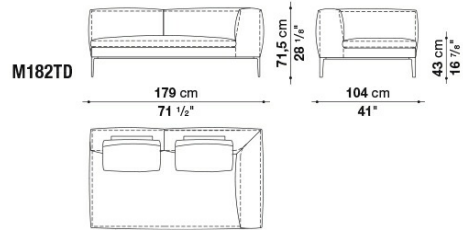

M182TD

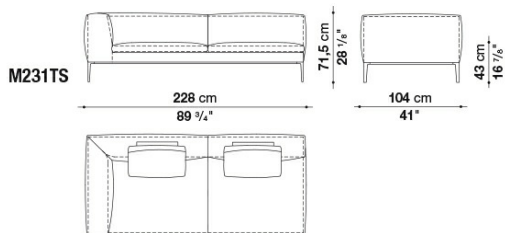

M231TS

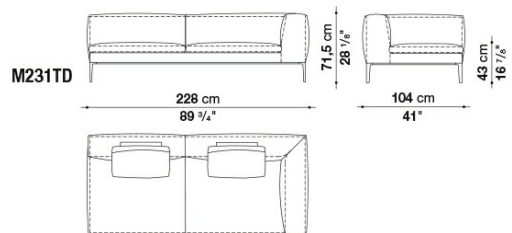

M231TD

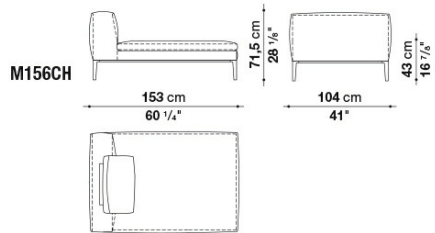

M156CH

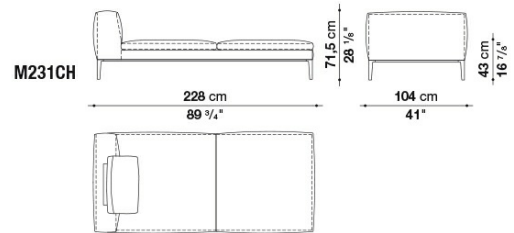

M231CH

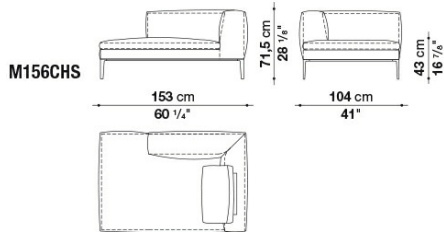

M156CHS

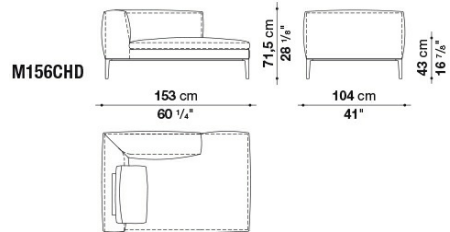

M156CHD

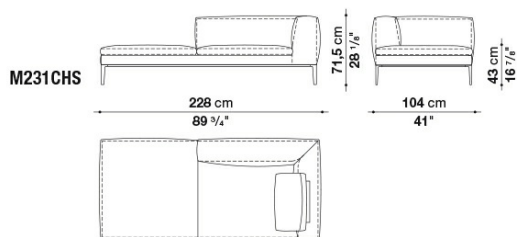

M231CHS

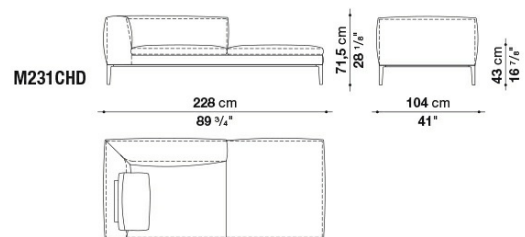

M231CHD

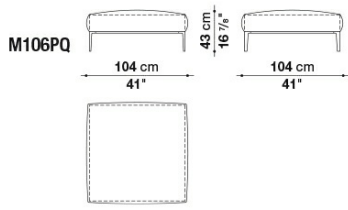

M106PQ

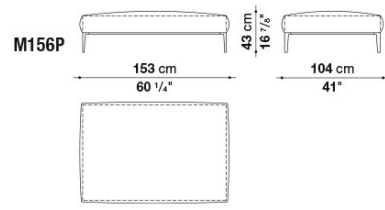

M156P

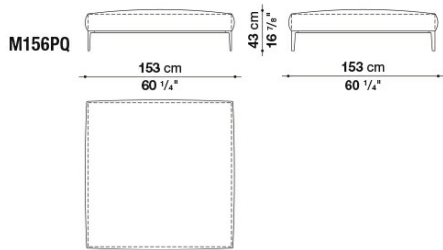

M156PQ

Compositions

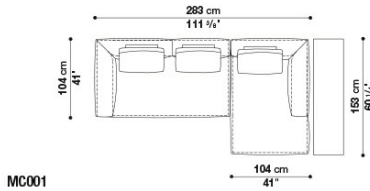

MC001

01

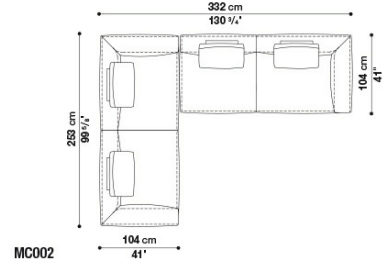

MC002

02

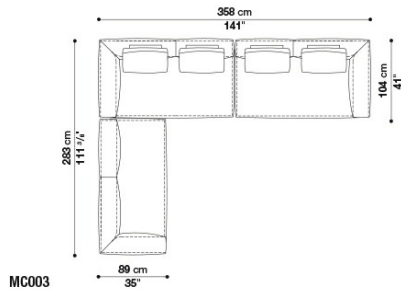

MC003

03

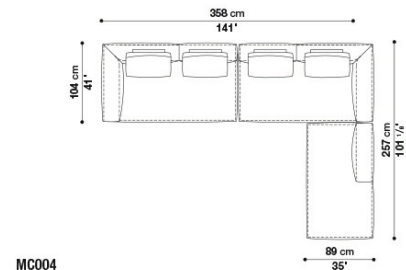

MC004

04

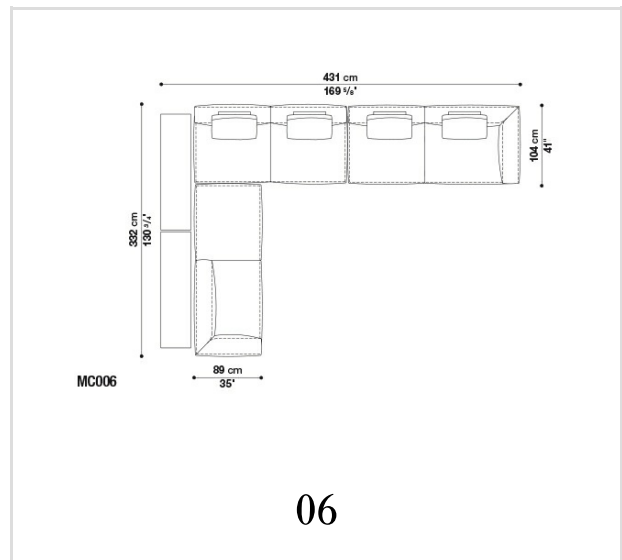
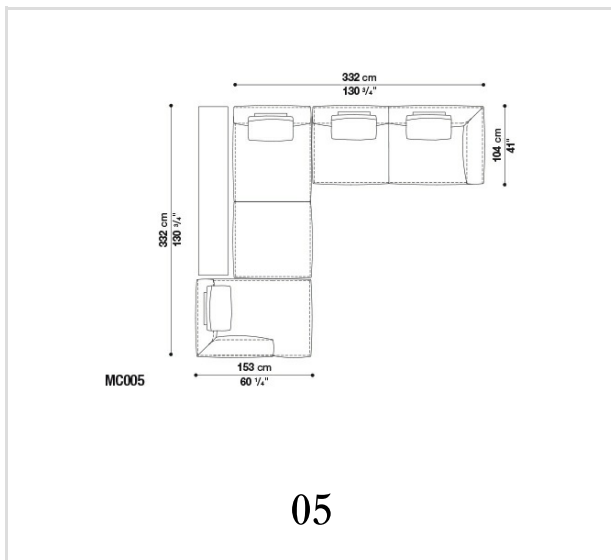

B&B Italia reserves the right to make technological and aesthetic improvements to its models, including changes to the sizes and materials, without notice. The technical drawings do not define the details of the product. The measurements shown are indicative and may undergo changes. In particular, the dimensions relevant to the padded parts are subject to usage tolerances over time caused by the normal adjustment of the padding. For the specific information, please contact the dealer closest to you.