

Molteni & C

HUGO — VINCENT VAN DUYSSEN 2018

1—
2



Hugo is a complement, a collection of versatile and contemporary accessories, but with firm roots in tradition. It is distinguished by severe proportions and classic quotations, by the tactile value of wood. But such memories are ruffled by a contemporary breeze that brings an air of simplicity and the tension of “Less is more”.

DATASHEET

REGISTERED
DESIGN

IX.2018

moltenigroup.com

Dimensions in centimeters and inches. The right to discontinue and make changes is reserved. This information is based on the latest product information available at the time of printing.

FINISHES

FINISHES OF LEGS AND LOWER SHELF

eucalyptus
graphite oak
walnut

FINISHES OF WOOD UPPER SHELF

eucalyptus
graphite oak
walnut

FINISHES OF MARBLE UPPER SHELF

orient grey
emperador dark
calacatta gold

Molteni & C

TECHNICAL INFORMATION

WOOD TOP, BASE, CENTRAL SUPPORT

Medium density fiber panel, formed and covered with sliced veneer in Eucalyptus (*Eucalyptus globulus*) and Oak (*Quercus*) or Walnut (*Juglans nigra*).

MARBLE TOP

Marble with finishes from the range.

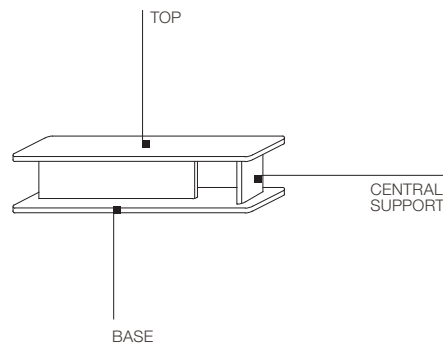

DIMENSIONS

rectangular small tables

HTV1

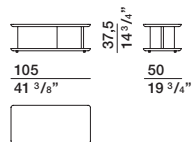

HTV2

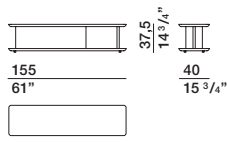

square small tables

HTV3

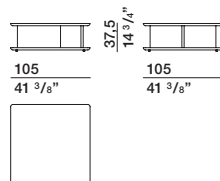

HTV4

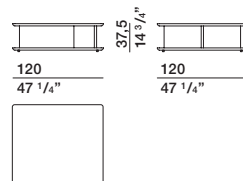

DATASHEET

REGISTERED
DESIGN

IX.2018

FINISHES MOLTENI&C RANGE

IX.2018

	MATT LACQUER	GLOSSY LACQUER	COLOURED GLASS	ETCHED COLOURED GLASS	CARTAPAGLIA LACQUERED <i>only Gliss Master</i>	STOPSOL GLASS TRANSPARENT STOPSOL GLASS
CHALK WHITE	•	•	•	•	•	
PEARL	•	•	•	•	•	
SILICA	•	•	•	•	•	
SAND	•	•	•	•	•	
DOVE GREY	•	•	•	•	•	
PLATINUM	•	•	•	•	•	
DUNE	•	•	•	•	•	
CLAY	•	•	•	•	•	
DOLOMITE GREY	•	•	•	•	•	
COPPER	•	•	•	•	•	
RUST	•	•	•	•	•	
RUBY	•	•	•	•	•	
CARAMEL	•	•	•	•	•	
MOKA	•	•	•	•	•	
MUSTARD	•	•	•	•	•	
LIGHT BLUE GREY	•	•	•	•	•	
PEWTER COLOUR	•	•	•	•	•	
ANTHRACITE	•	•	•	•	•	
BLACK	•	•	•	•	•	
STOPSOL						•
LESSLESS RED	•					
		only matt lacquer				

Molteni & C

FINISHES MOLTENI&C RANGE

IX.2018

WOODS

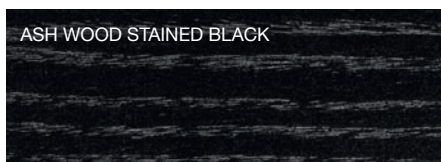
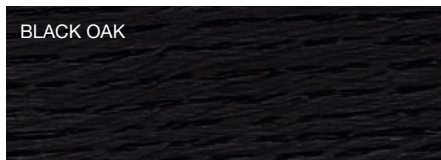
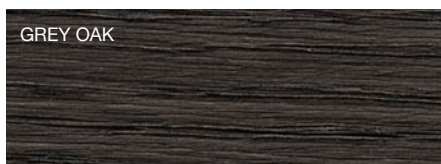
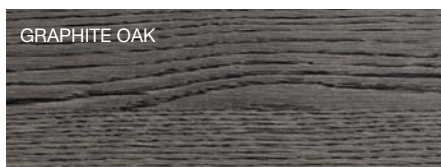
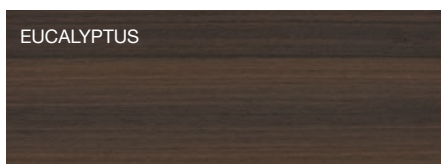

MARBLES

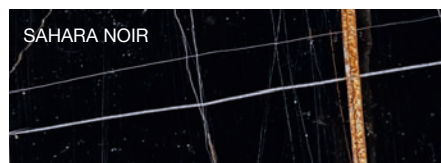
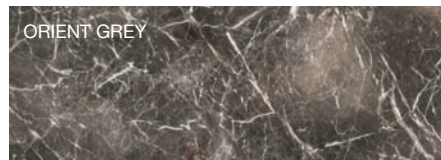
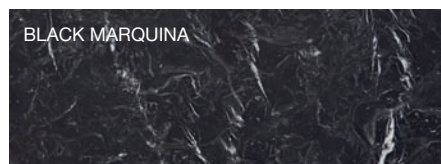
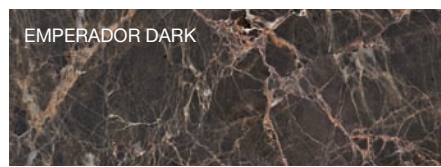
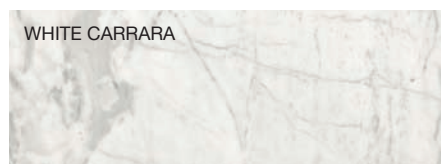

METAL PARTS

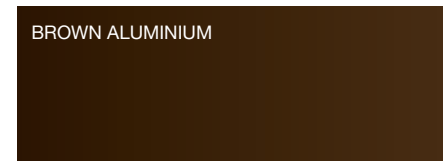
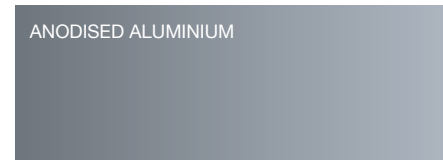
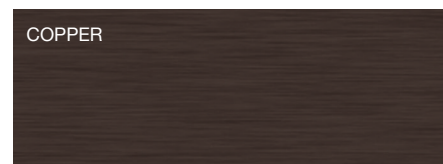
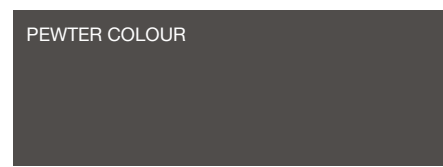
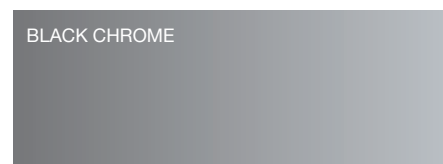

The finishes shown are indicative and refer to the entire production range. We recommend that you consult the "Colour Range" samples which shown the complete range of finishes, including those not shown here. Molteni&C reserves the right to modify the range without warning.

Molteni & C

FINISHES MOLTENI&C RANGE

IX.2018

MELAMINE FRONT
GLISS MASTER

CARTAPAGLIA WHITE

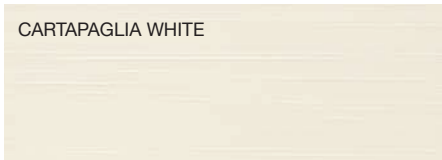

CARTAPAGLIA ANTHRACITE



CARTAPAGLIA SILICA



GRAFFIATO SILICA



GRAFFIATO BRONZE



SILK DOVE GREY



SILK SILICA



SILK CHALK WHITE



MELAMINE STRUCTURE
GLISS MASTER

WHITE SHANTUNG

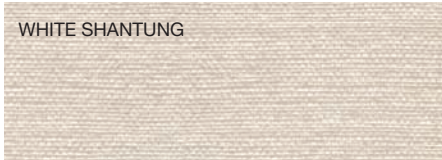

GREY SHANTUNG



MELAMINE STRUCTURE
GLISS MASTER, MASTER DRESSING,
GLISS WALK-IN

SILVER CEMBRAN



LARIX DARK

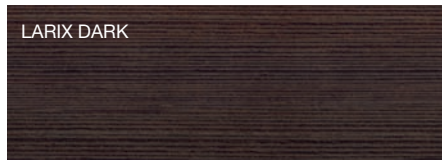

MELAMINE STRUCTURE
GLISS MASTER, MASTER DRESSING

WHITE



ECO SKIN

IVORY



HEMP



MINK



DARK BROWN

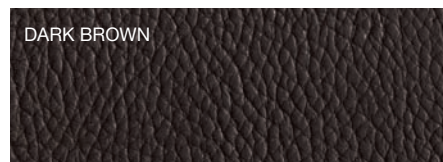

GREY



FINE GRAIN

FINE GRAIN

