

Patricia Urquiola interprets the happiness of life outdoors with a collection full of playful designs with rounded and sinuous shapes. The collection stands out for its environmentally sensitive approach using innovative, sustainable, completely Made in Italy materials thanks to the research of Cassina LAB, the collaboration between Cassina's Research and Development Centre and Poli.design of the Politecnico di Milano.

The two-seater sofa and three combinable modules – a small and large terminal and a central element for creating cosy compositions – have a lacquered AISI 304 stainless steel frame supporting panels made of RFM®, a 100% recyclable, hand-finished, recycled, glass-reinforced plastic. The backrest features the artisan weaving of polypropylene and nylon rope, while the two backrest cushions and the seat cushion are padded with 100% recycled fibre wadding obtained from PET and covered with a resistant, hypoallergenic fabric in 100% recycled PET polyester yarn. Fringes of the cushions in the same shades as the rope are optional.

### Gallery



### Dimensions

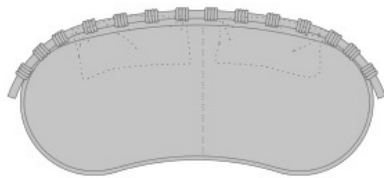
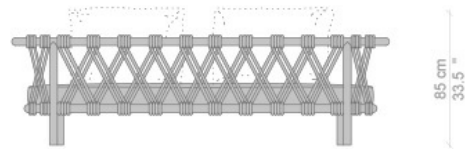
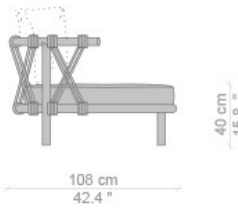
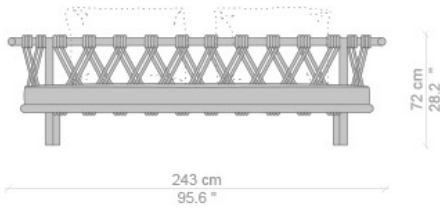
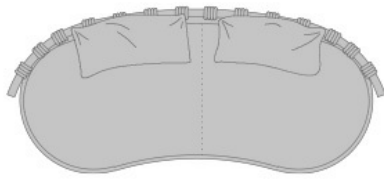
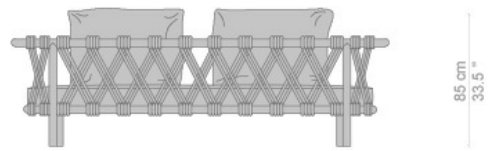
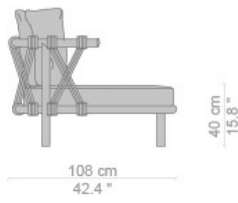
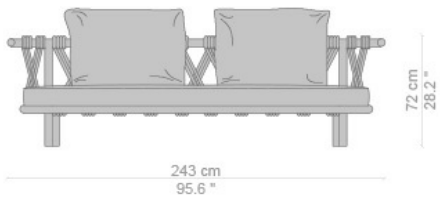

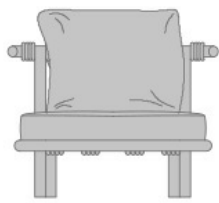

96 cm  
37.8 "

72 cm  
28.2 "



85 cm  
33.5 "

40 cm  
15.8 "

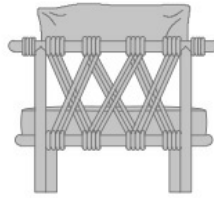

85 cm  
33.5 "

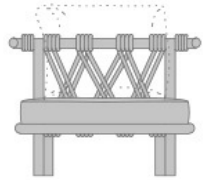
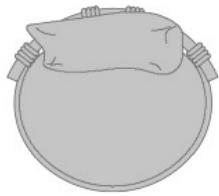

96 cm  
37.8 "

72 cm  
28.2 "



85 cm  
33.5 "

40 cm  
15.8 "

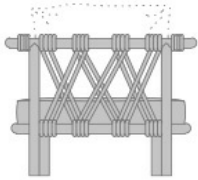

85cm  
33.5 "

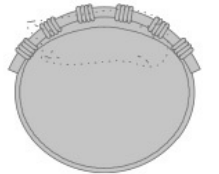

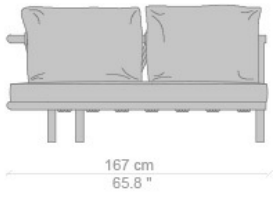

72 cm  
28.2"

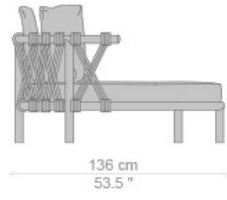

40 cm  
15.8"

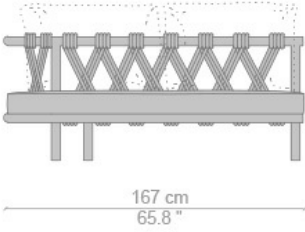
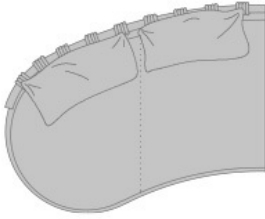
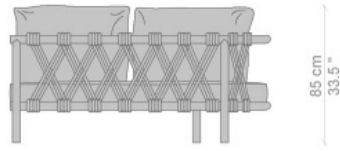

72 cm  
28.2"

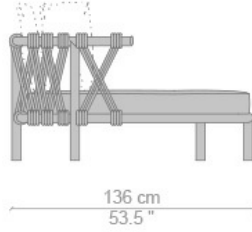

40 cm  
15.8"

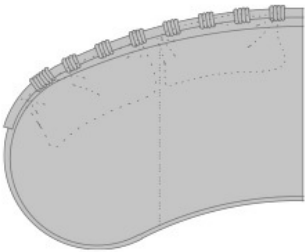
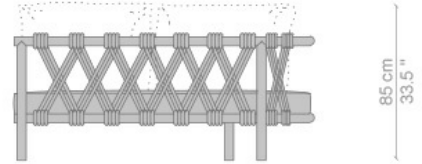

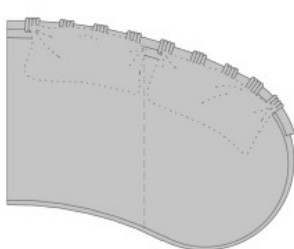
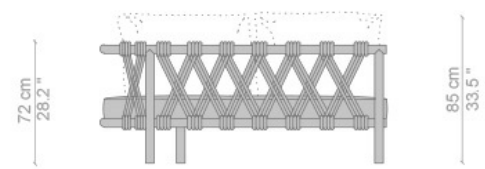
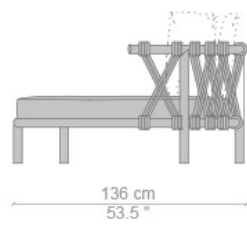
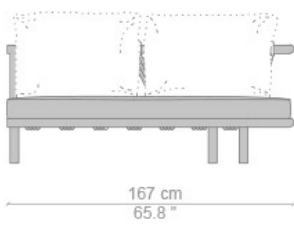
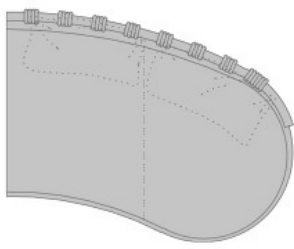
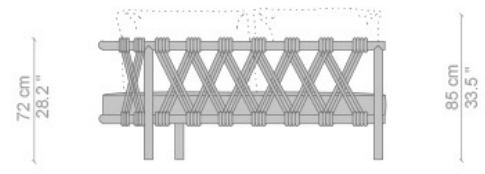
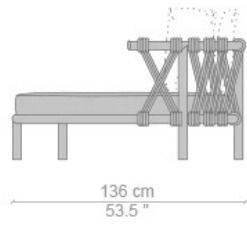
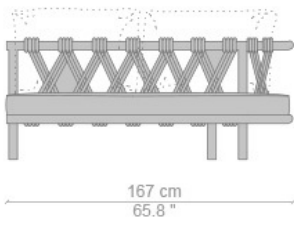

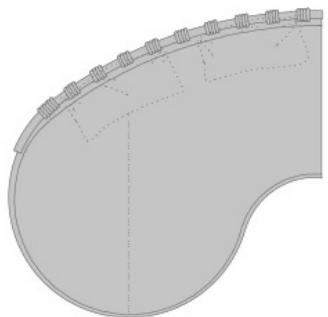
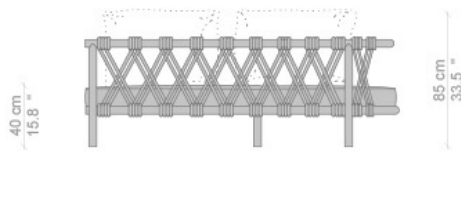
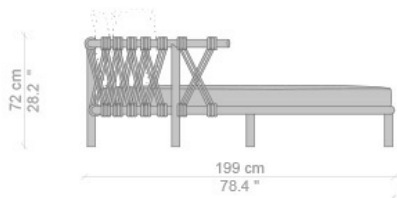
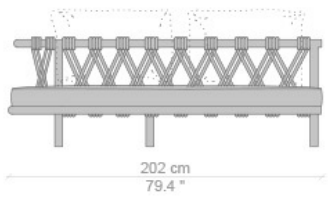
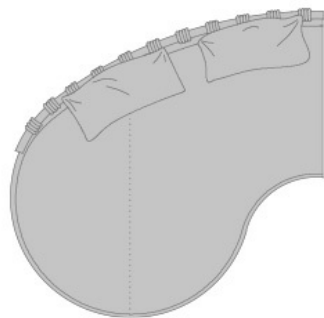
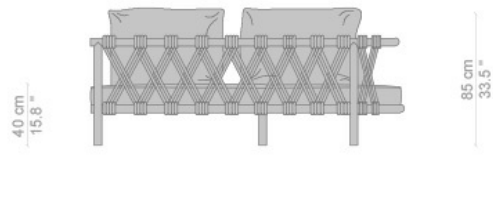
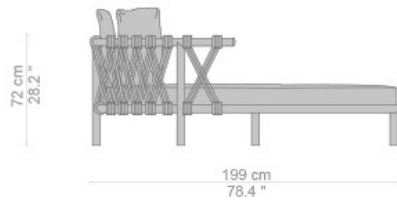
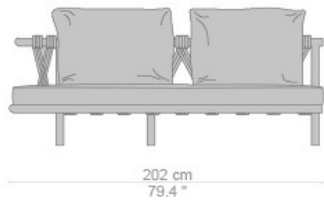

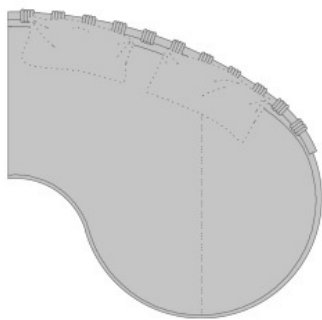
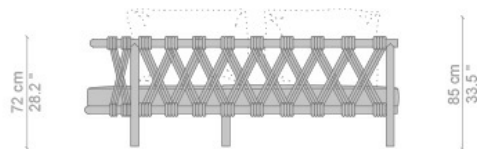
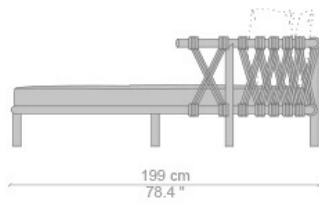
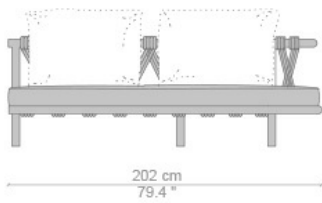
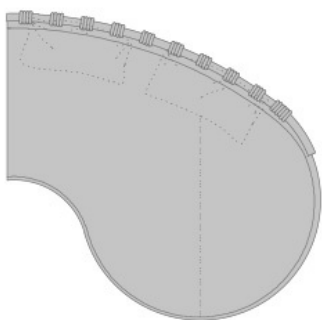
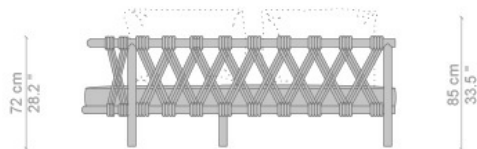
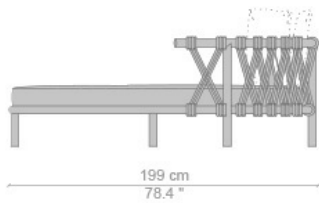
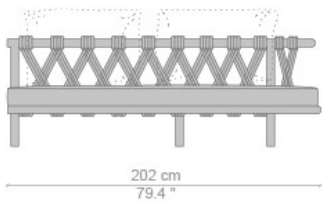

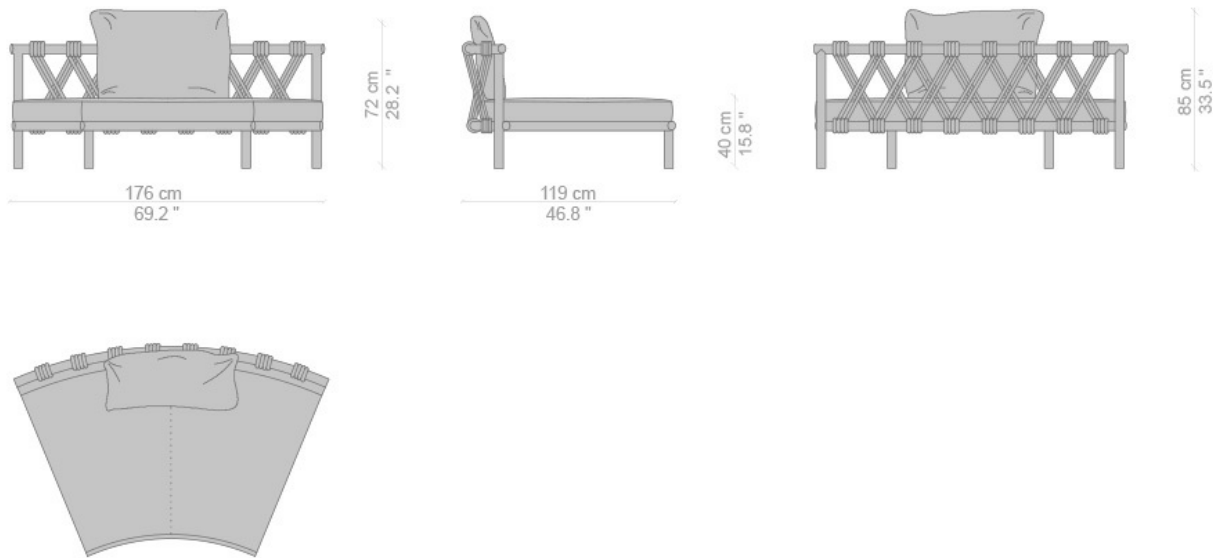

## Designer



**Patricia Urquiola**

*Patricia Urquiola was born in Oviedo (Spain) in 1961. Lives and works in Milan. She attended the University of Architecture at Madrid Polytechnic and Milan Polytechnic, where she graduated in 1989 with Achille Castiglioni.*

*Assistant lecturer to Achille Castiglioni and Eugenio Bettinelli in Milan and Paris, responsible for the new product development office of DePadova, working with Vico Magistretti, head of Lissoni Associati's design group.*

*In 2001 she opened her own studio working on product design, architecture, and installations. Amongst her last projects of architecture: The museum of Jewel in Vicenza, Mandarin Oriental Hotel in Barcelona, das Stue Hotel in Berlin and the Spa of Four Seasons Hotel in Milan; showroom and installations for Gianvito Rossi, BMW, Cassina, Missoni, Moroso, Molteni, Officine Panerai, H&M, Santoni and the general concept of Pitti Immagine Firenze. She realize design products for the most important Italian and international companies, such as : Agape, Alessi, Axor-Hansgrohe, B&B Italia, Baccarat, Boffi, Budri, De Padova, Diade, Ferragamo, Flos, Gan, Georg Jensen, Glas Italia, Haworth, Kartell, Kettal, Kvadrat, Listone Giordano, Louis Vuitton, Molteni, Moroso, Mutina, Rosenthal and Verywood. Some of her products are exposed in various Museums and collections, such as MoMA in New York, Les arts decoratifs in Paris, the Museum of Design in Zurich, Vitra Design Museum in Basel, Victorian&Albert Museum in London, Stedelijk in Amsterdam and Triennale Museum in Milan.*

*She has won several international prizes and awards. Amongst others the Medalla de Oro al Mérito en las Bellas Artes (Gold Medal of fine arts) awarded by the Spanish Government; Order of Isabella the Catholic, awarded by His Majesty The King of Spain Juan Carlos I; "Designer of the decade" for two German magazines, Home and Häuser, "Designer of the Year" for Wallpaper, Ad Spain, Elle Decor International and Architektur und Wohnen Magazine. She is Ambassador of Expo Milano 2015. September 2015 Patricia Urquiola nominated Art Director of Cassina.*